

Creative Tracing Pages

KidSparkz Preschool Resources

These are not just your everyday boring tracing worksheets. Encourage creativity along with the development of hand muscles and eye-hand coordination. Decorate the letters, draw sets inside the numbers, make Shape People out of the shapes. Encourage imaginative group discussions with the "What does this look like?" pages. Fill in the details on the Theme Pages, color and decorate, cut out, make themed murals. There are SO MANY things to do with these tracing pages, besides tracing them!

Susan Portman Copyright 2007

Name: _____

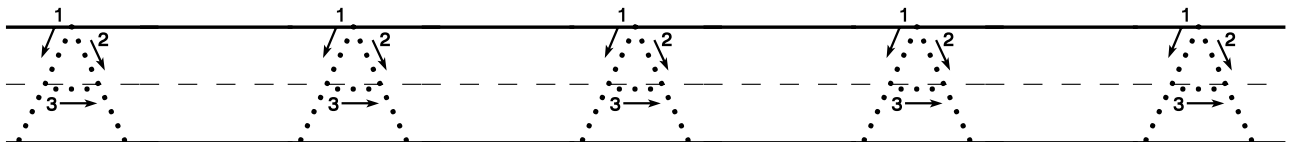
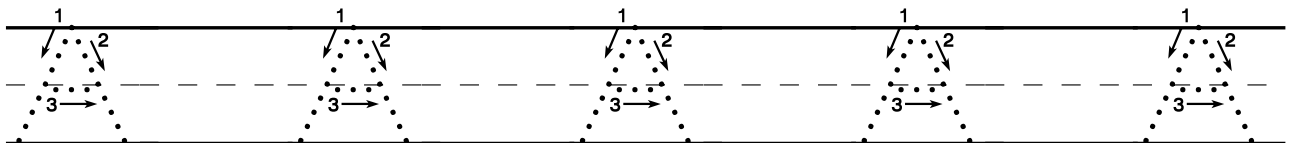
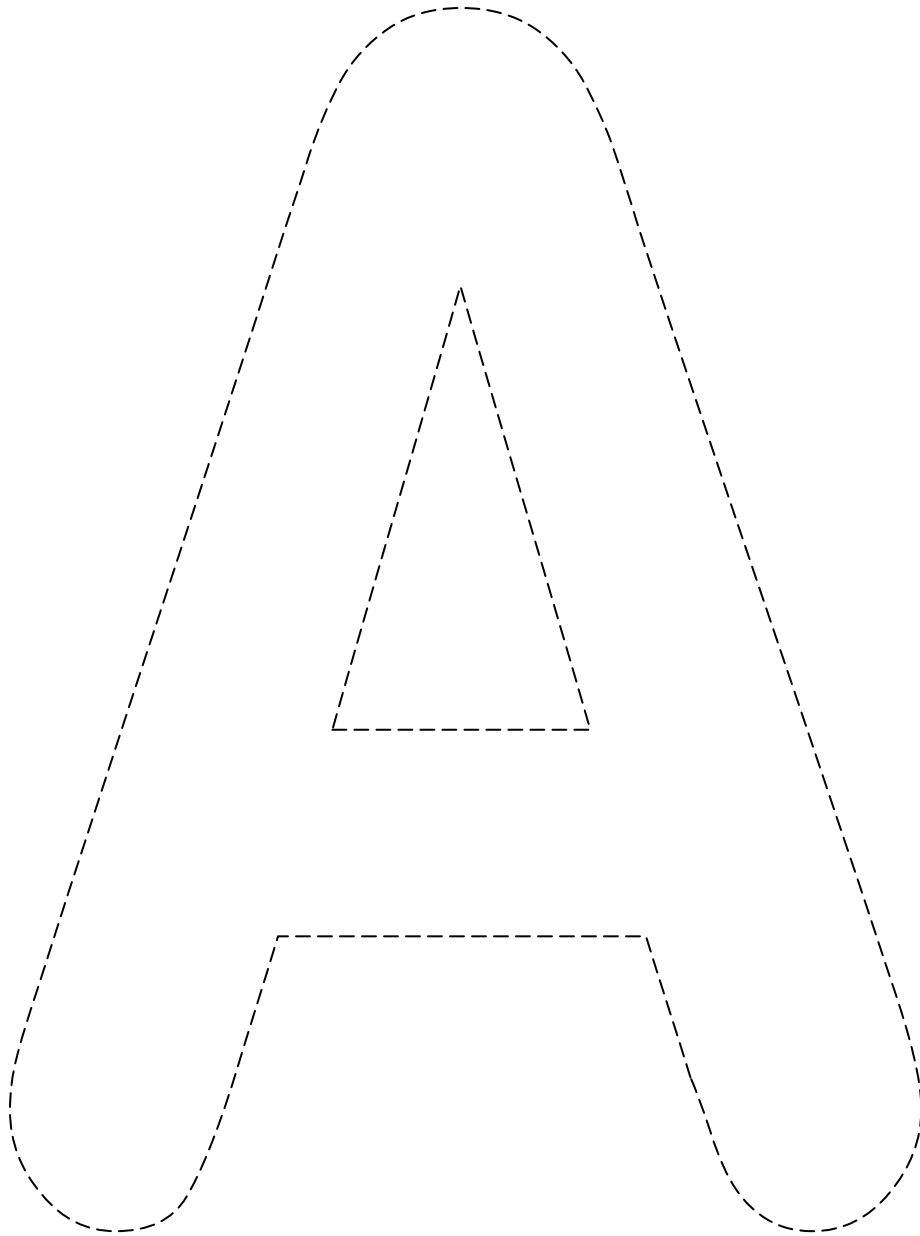

Name: _____

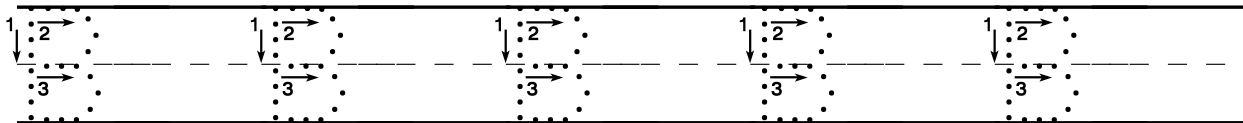
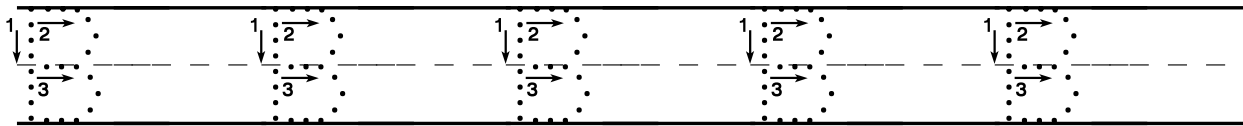
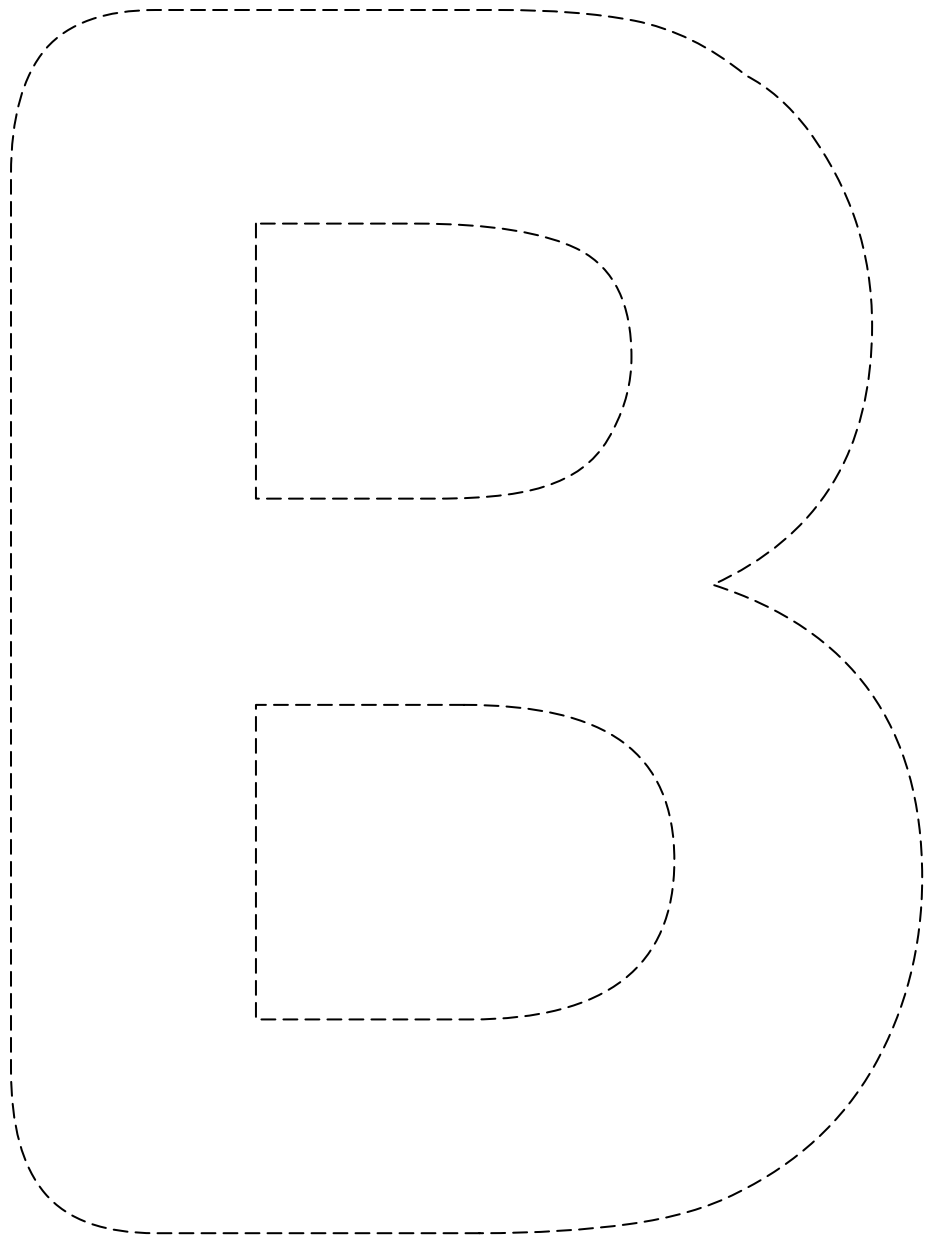

Name: _____

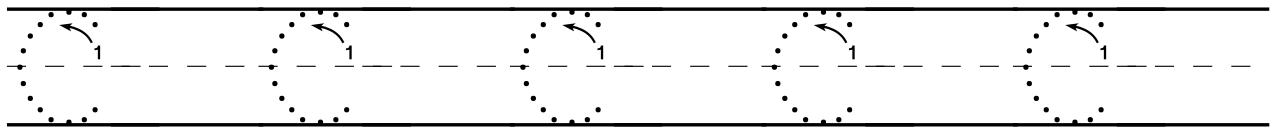
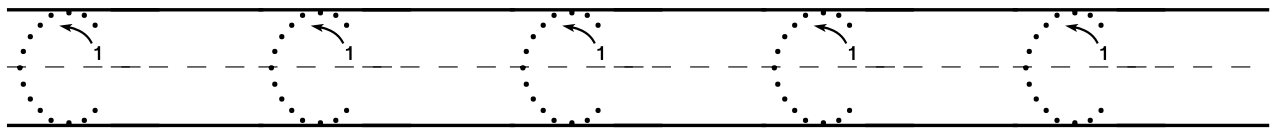
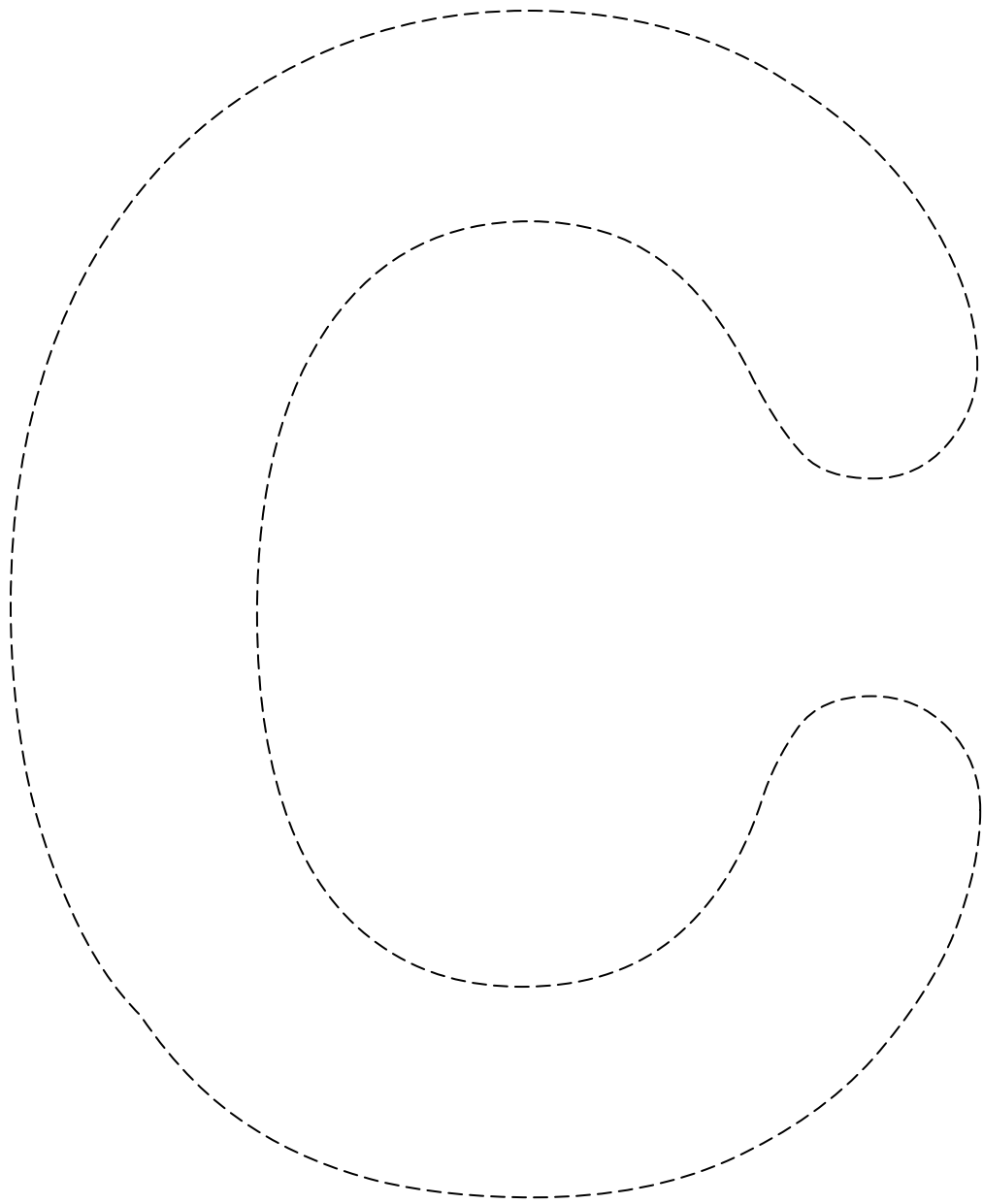

Name: _____

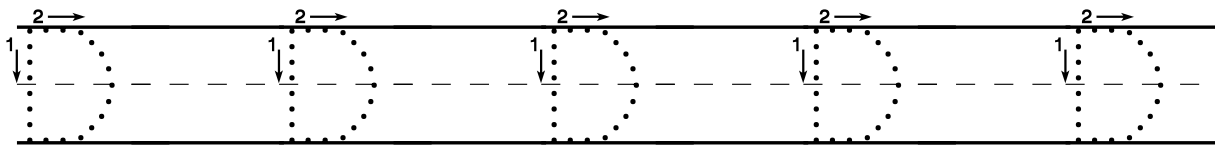
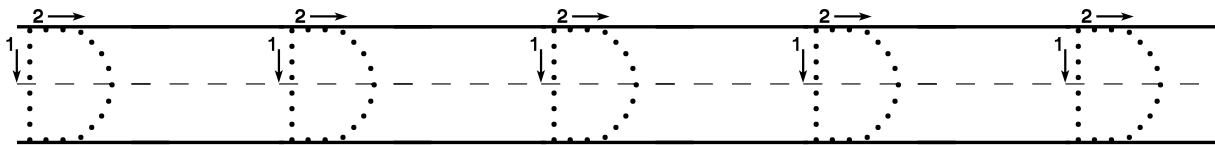
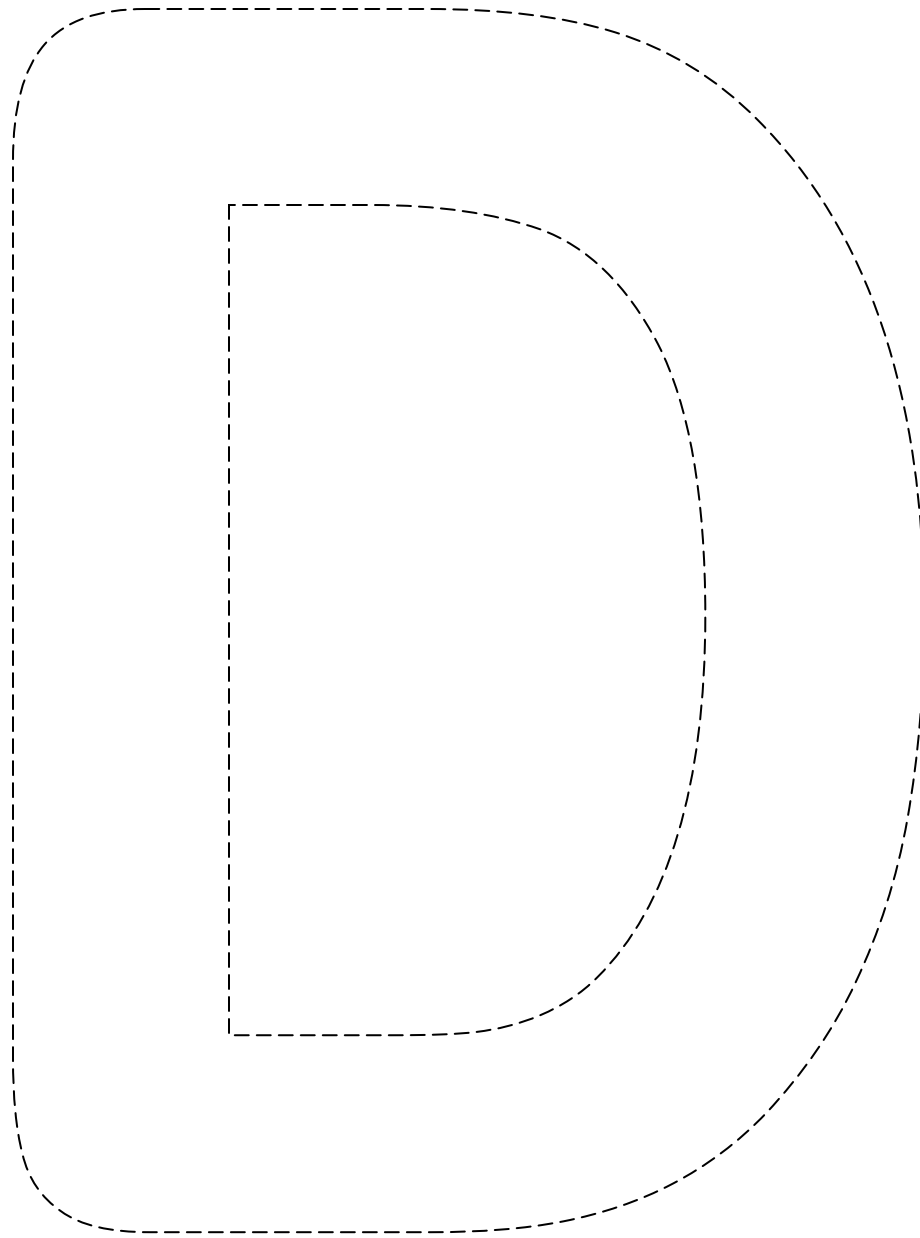

Name: _____

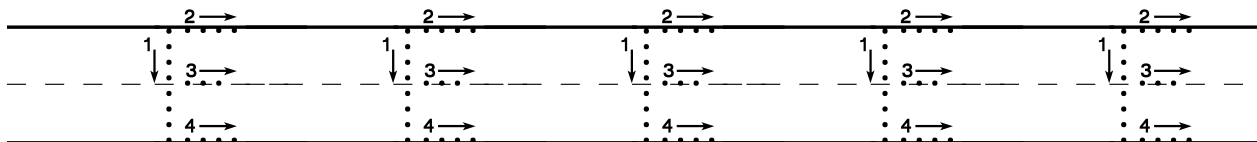
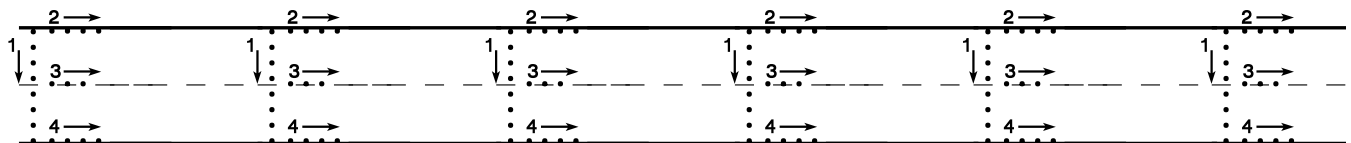
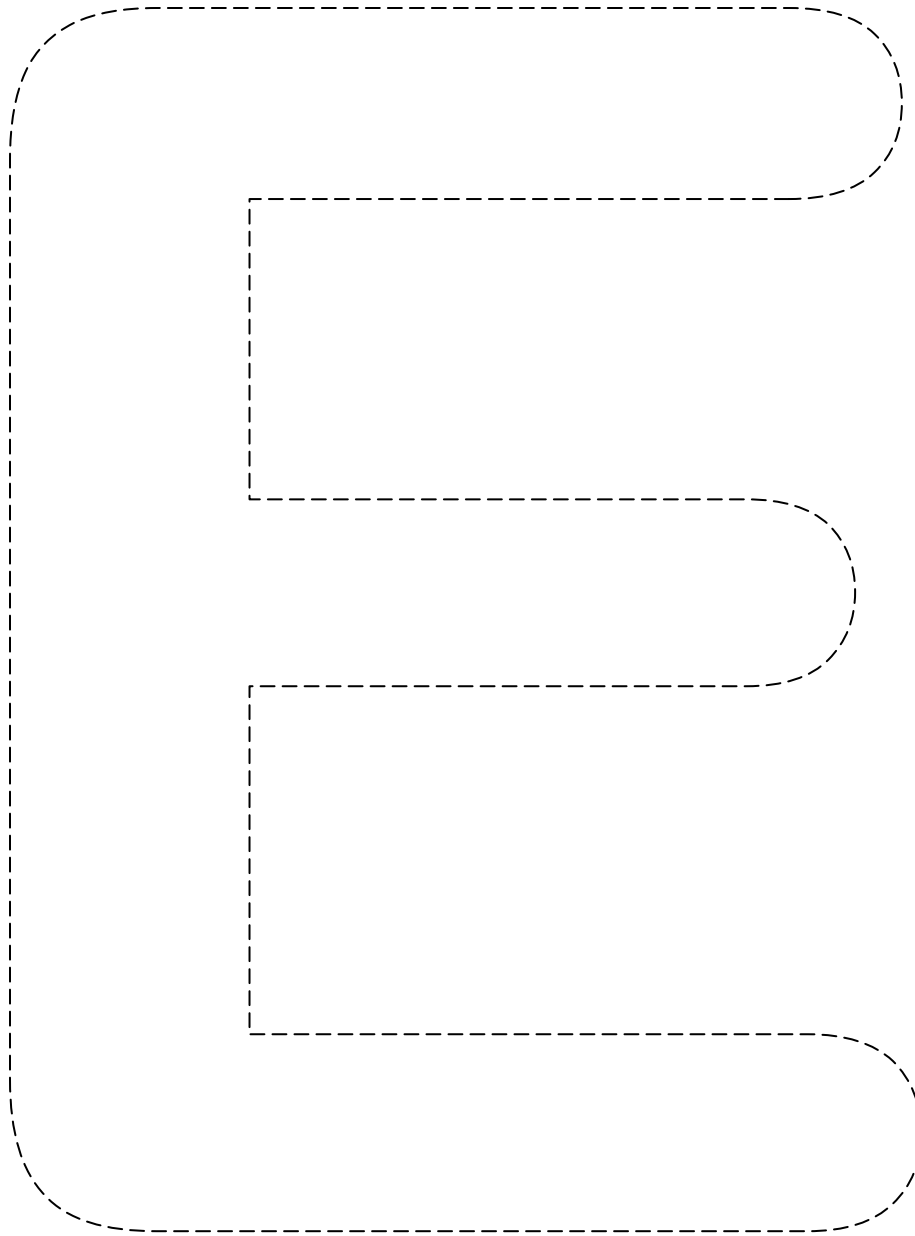

Name: _____

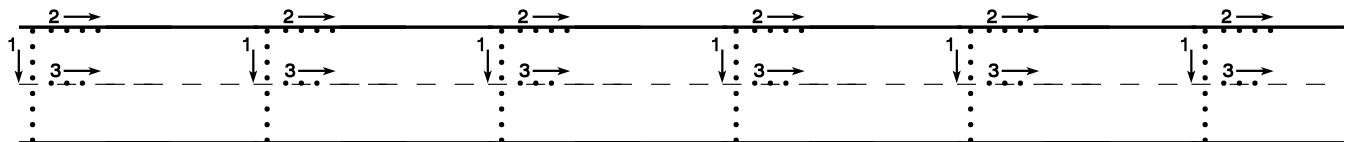
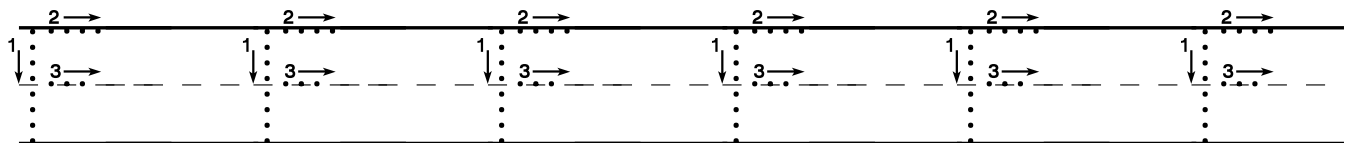
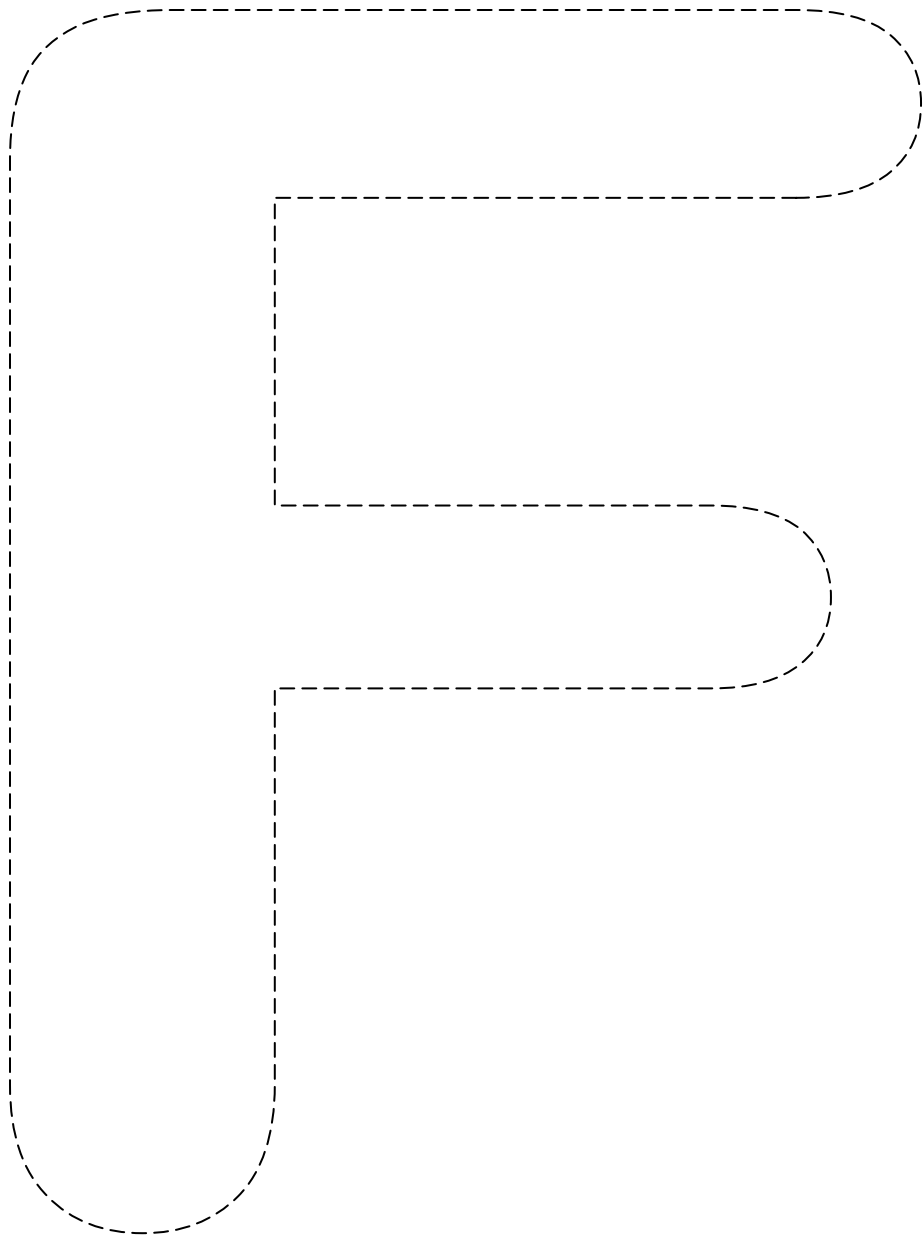

Name: _____

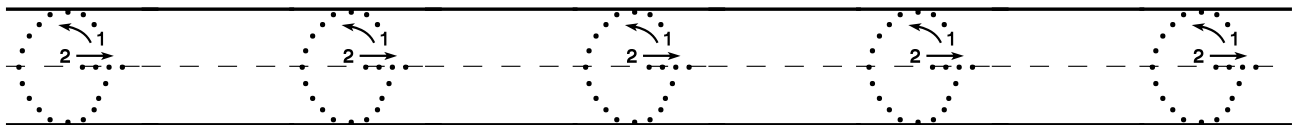
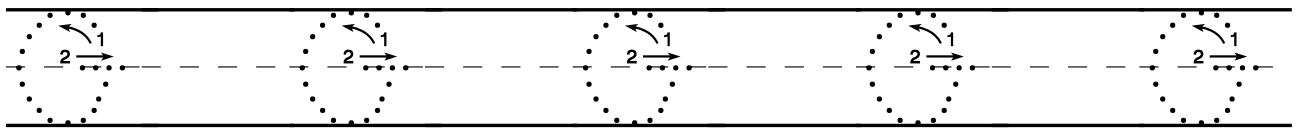
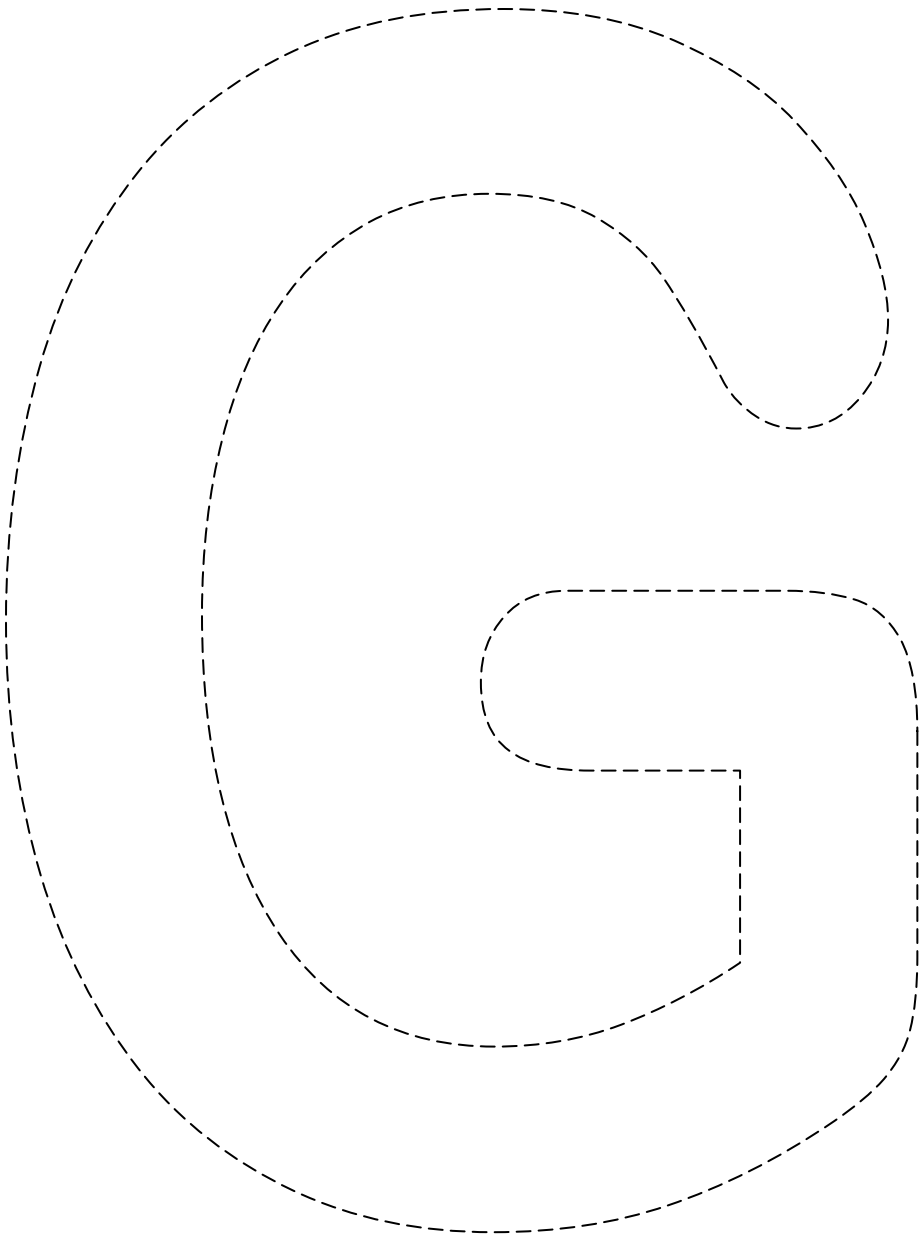

Name: _____

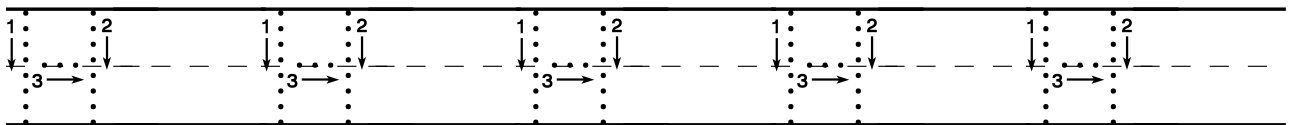
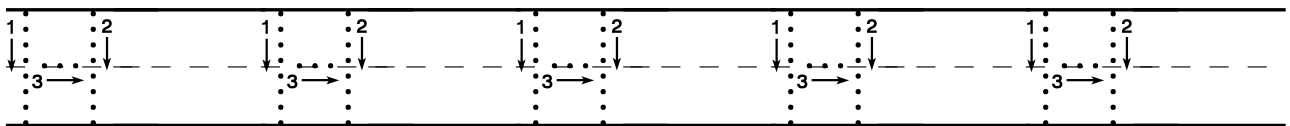
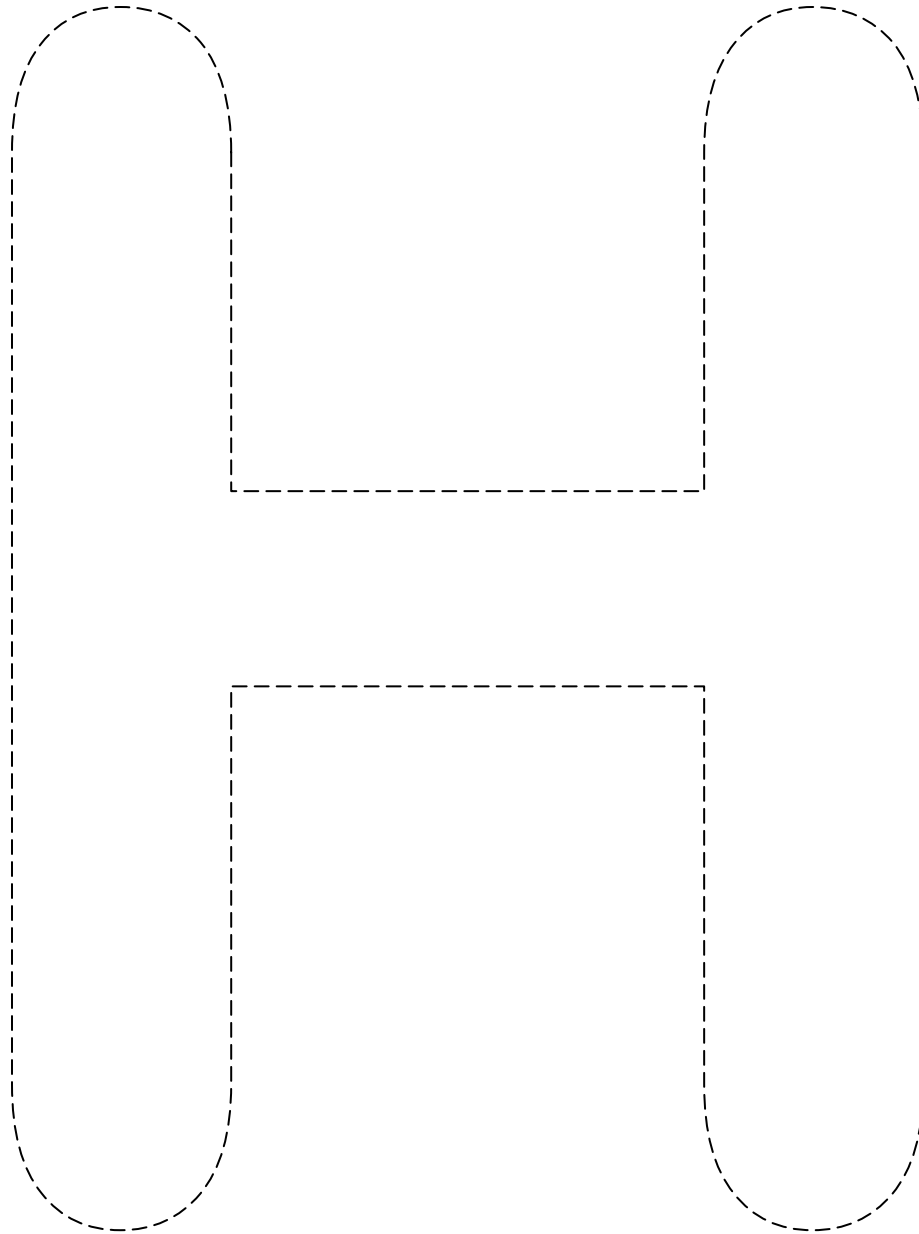

Name: _____

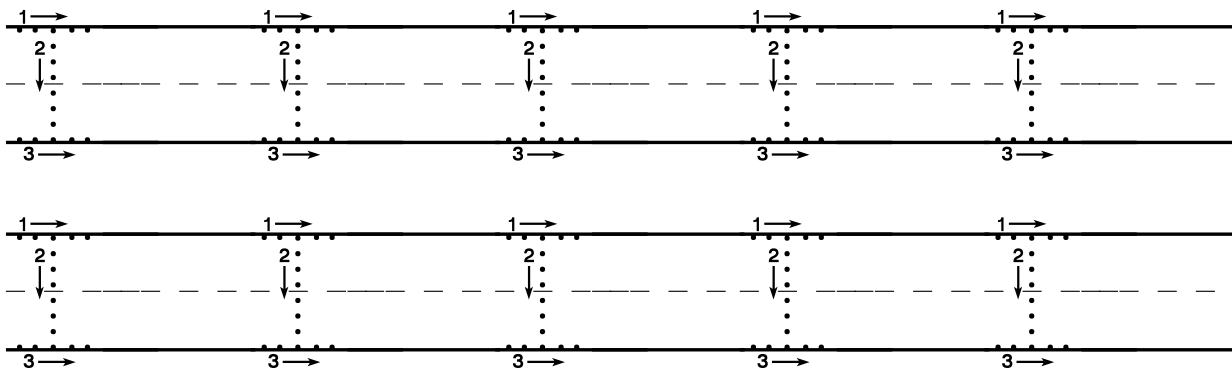
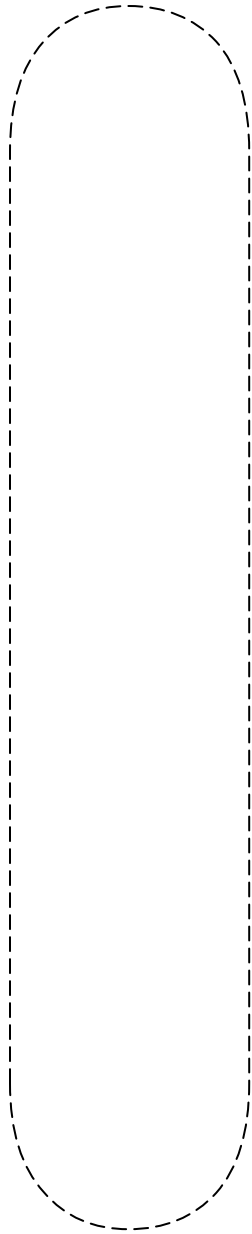

Name: _____

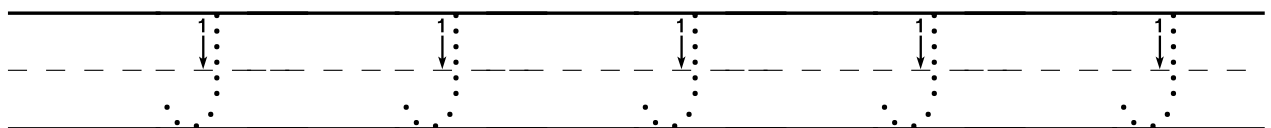
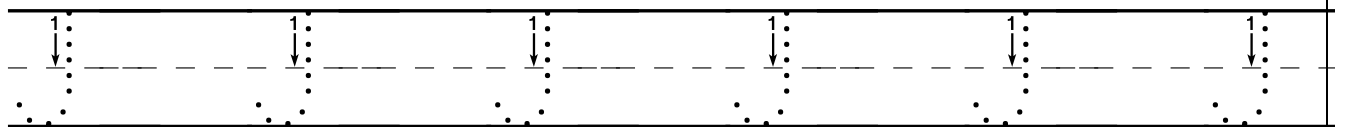
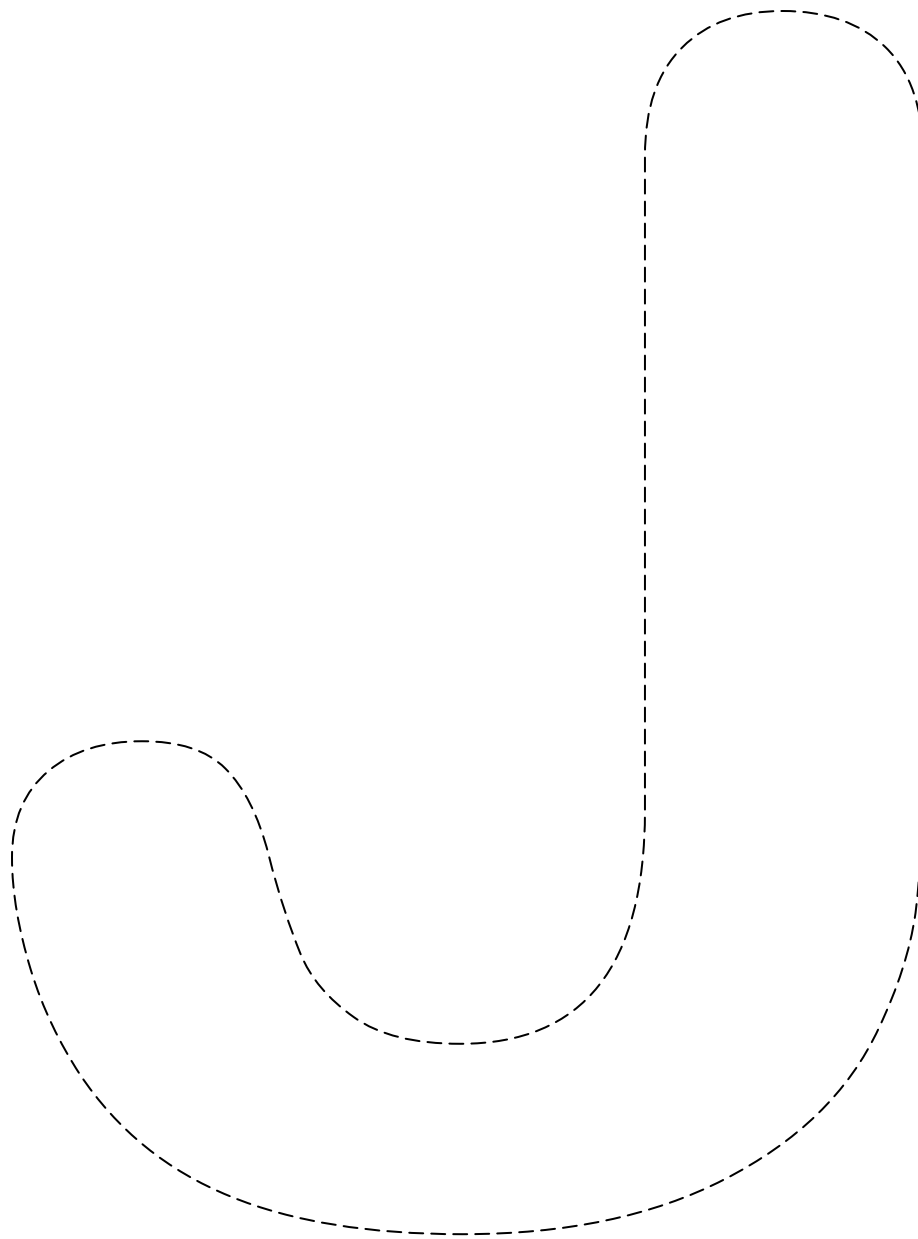

Name: _____

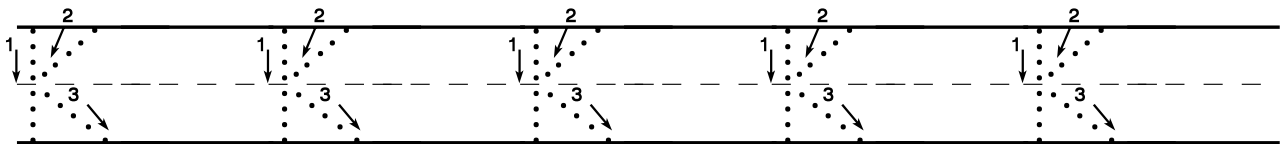
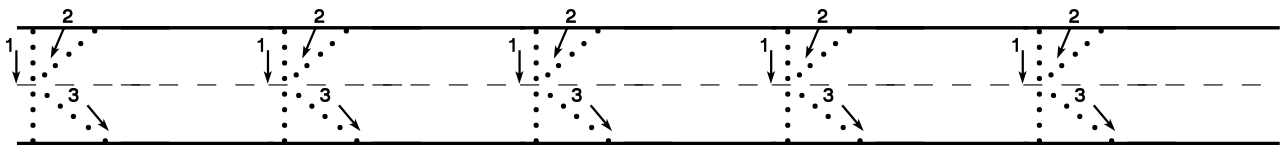
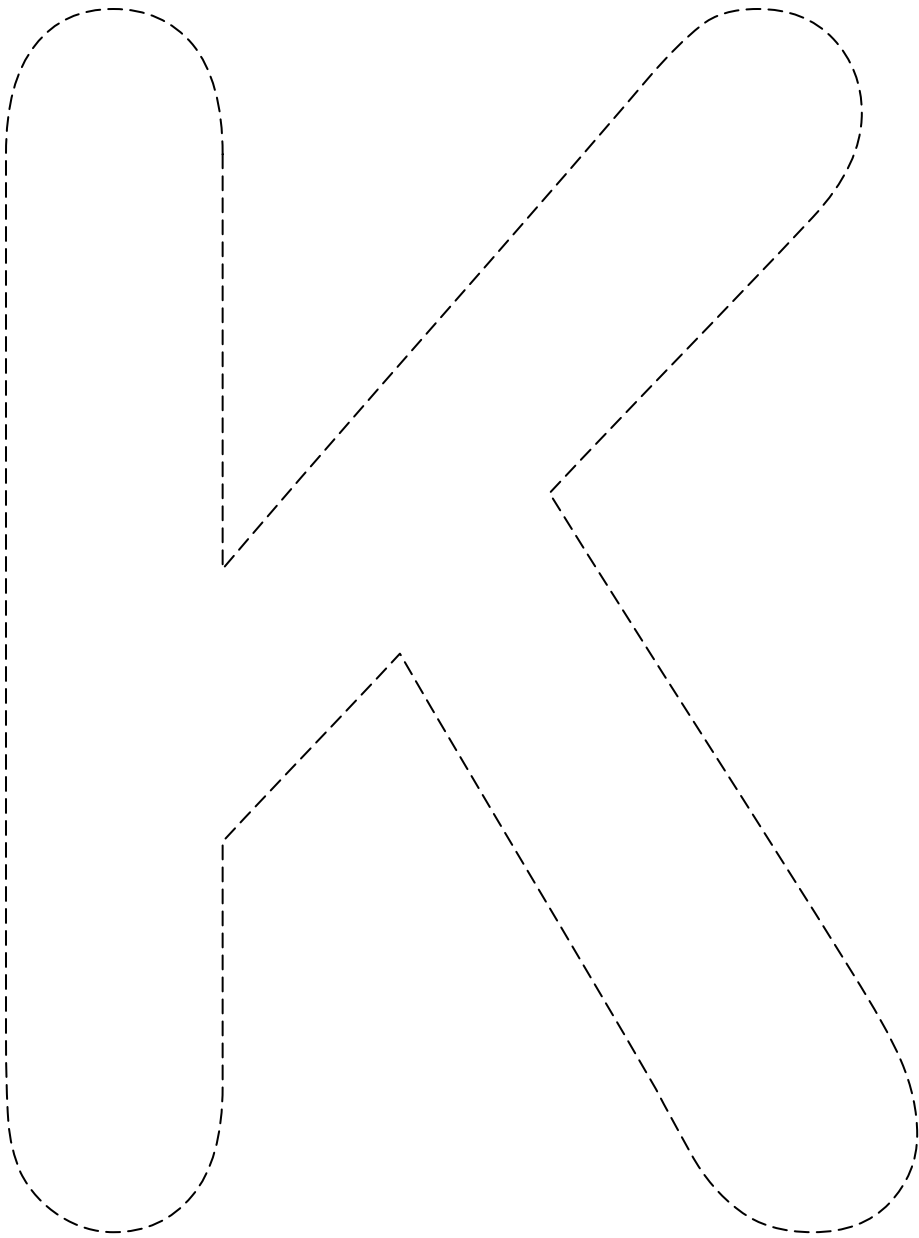

Name: _____

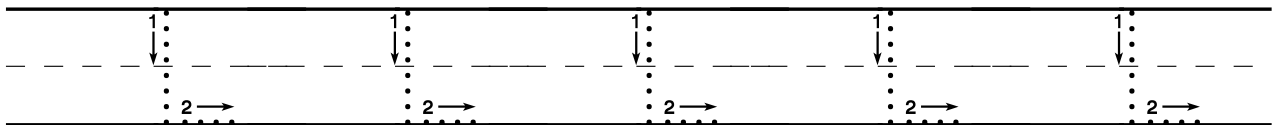
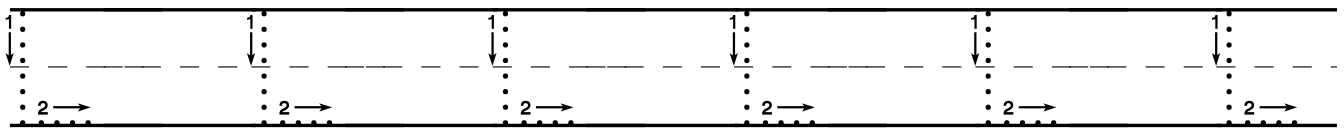
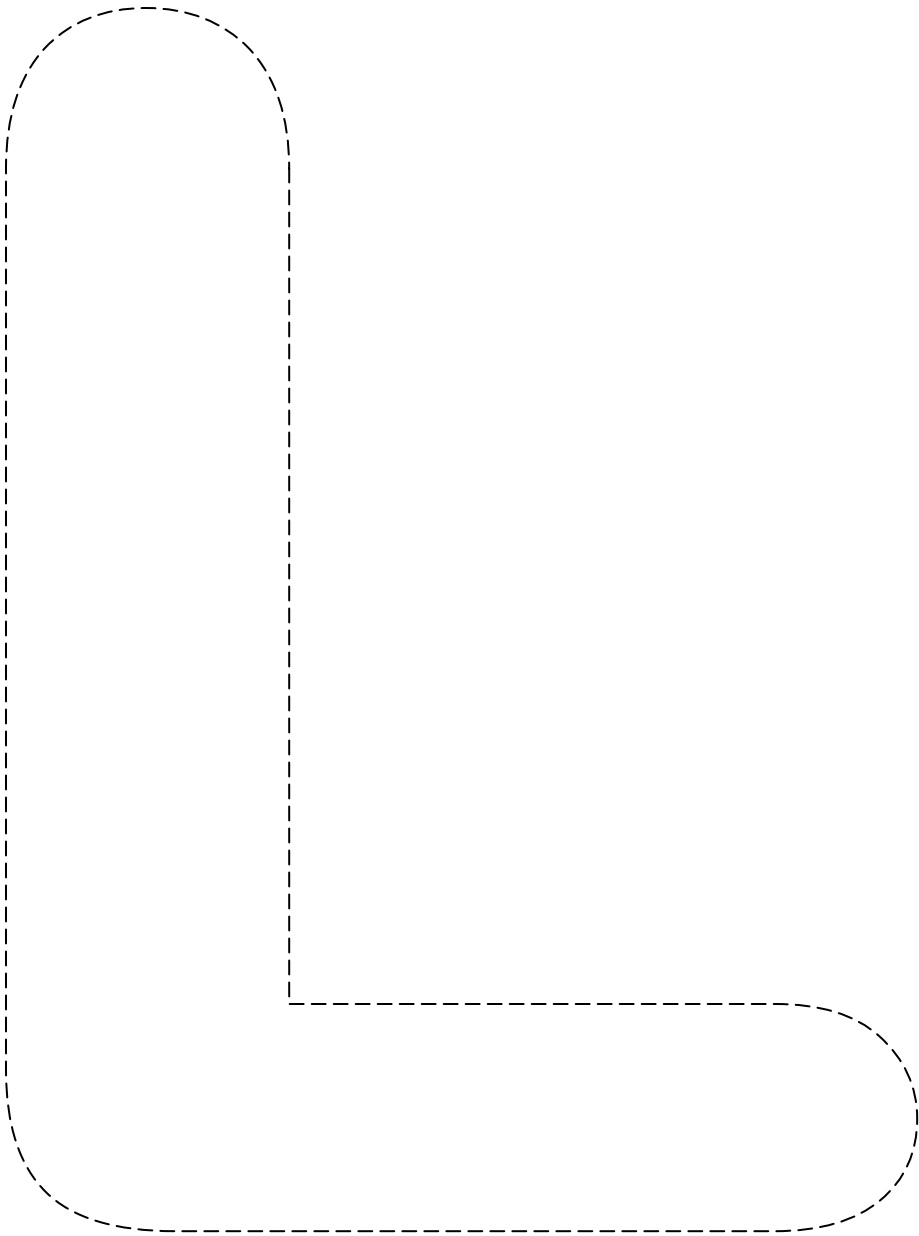

Name: _____

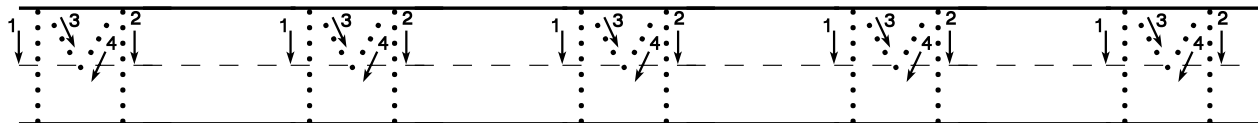
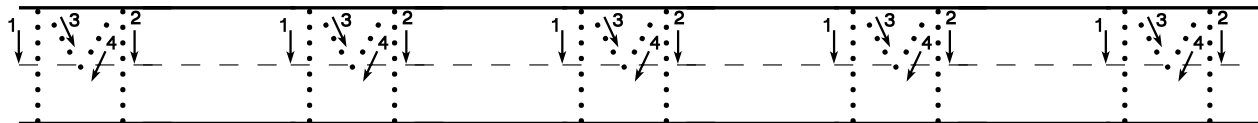
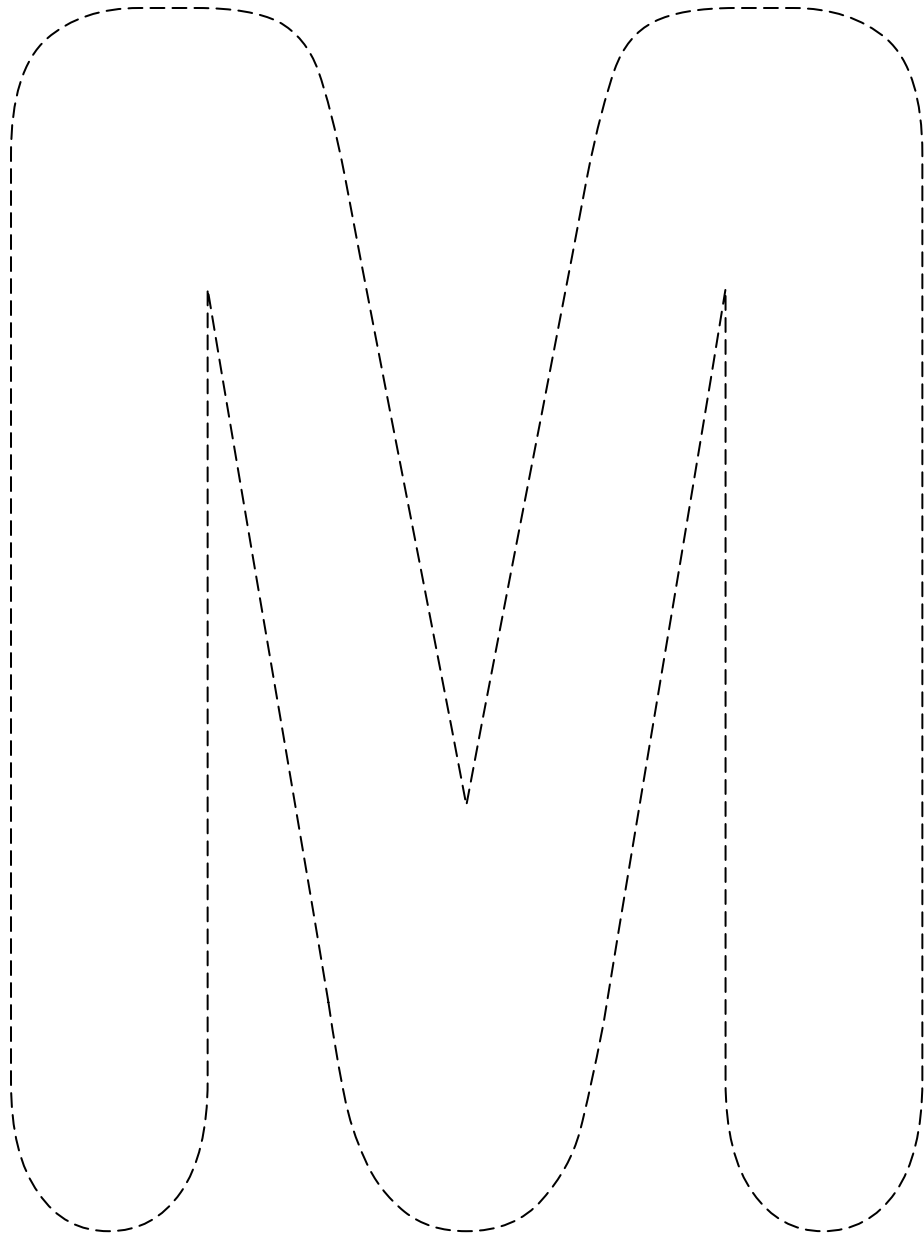

Name: _____

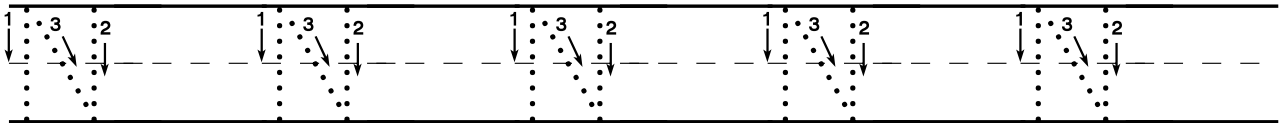
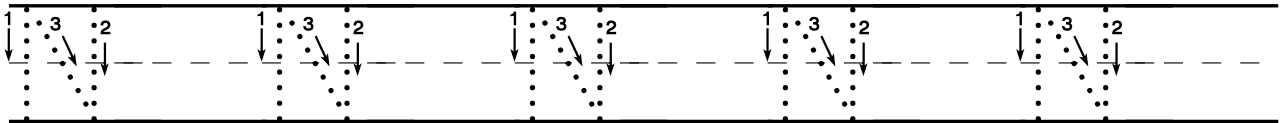
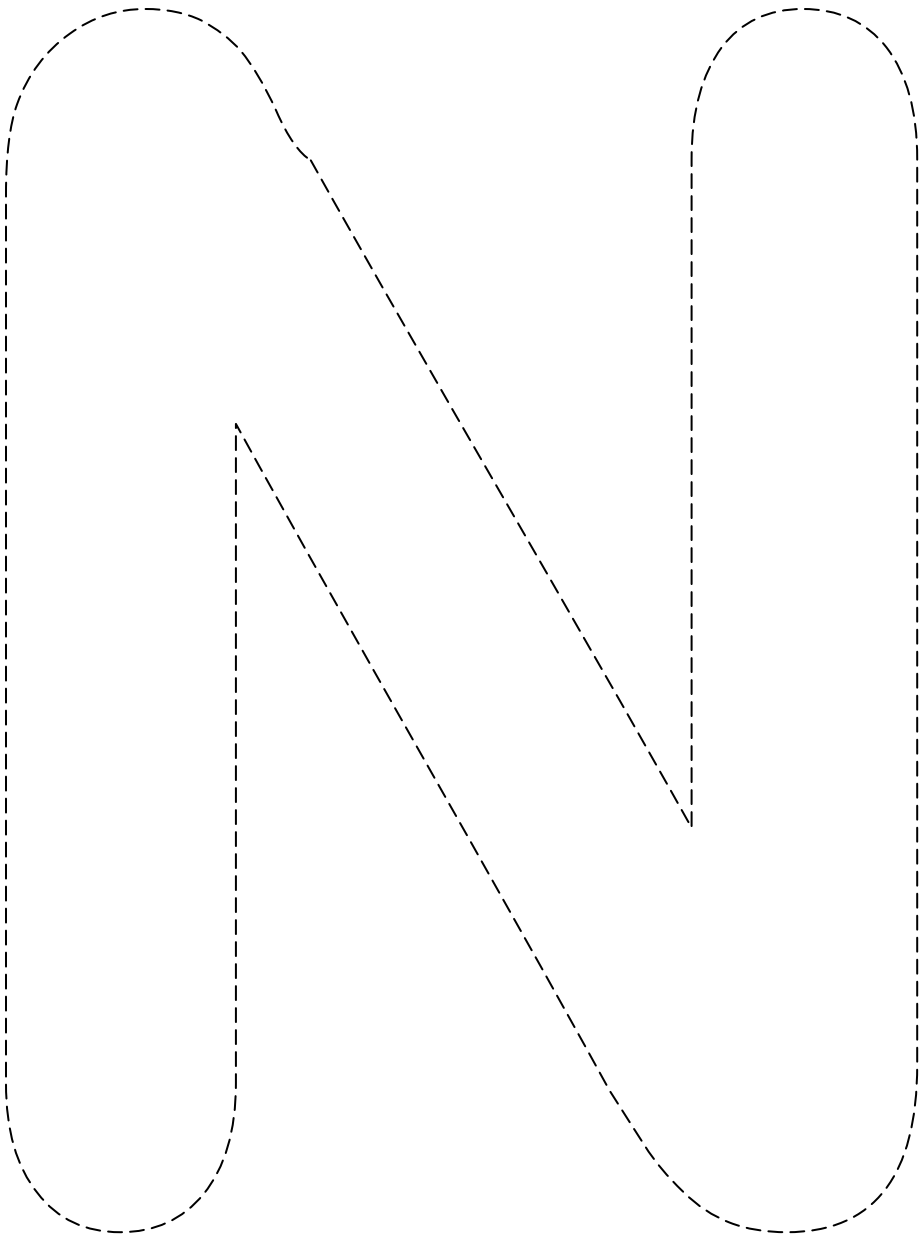

Name: _____

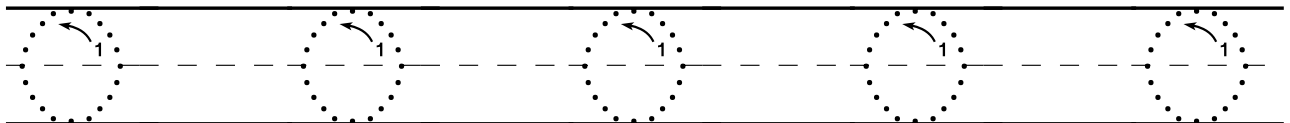
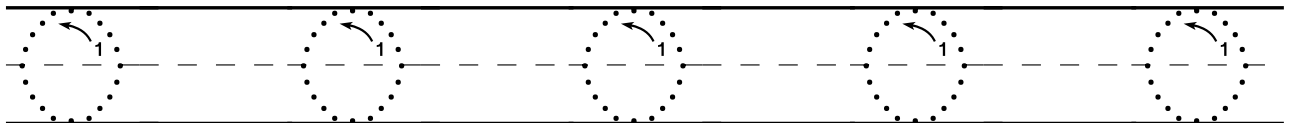
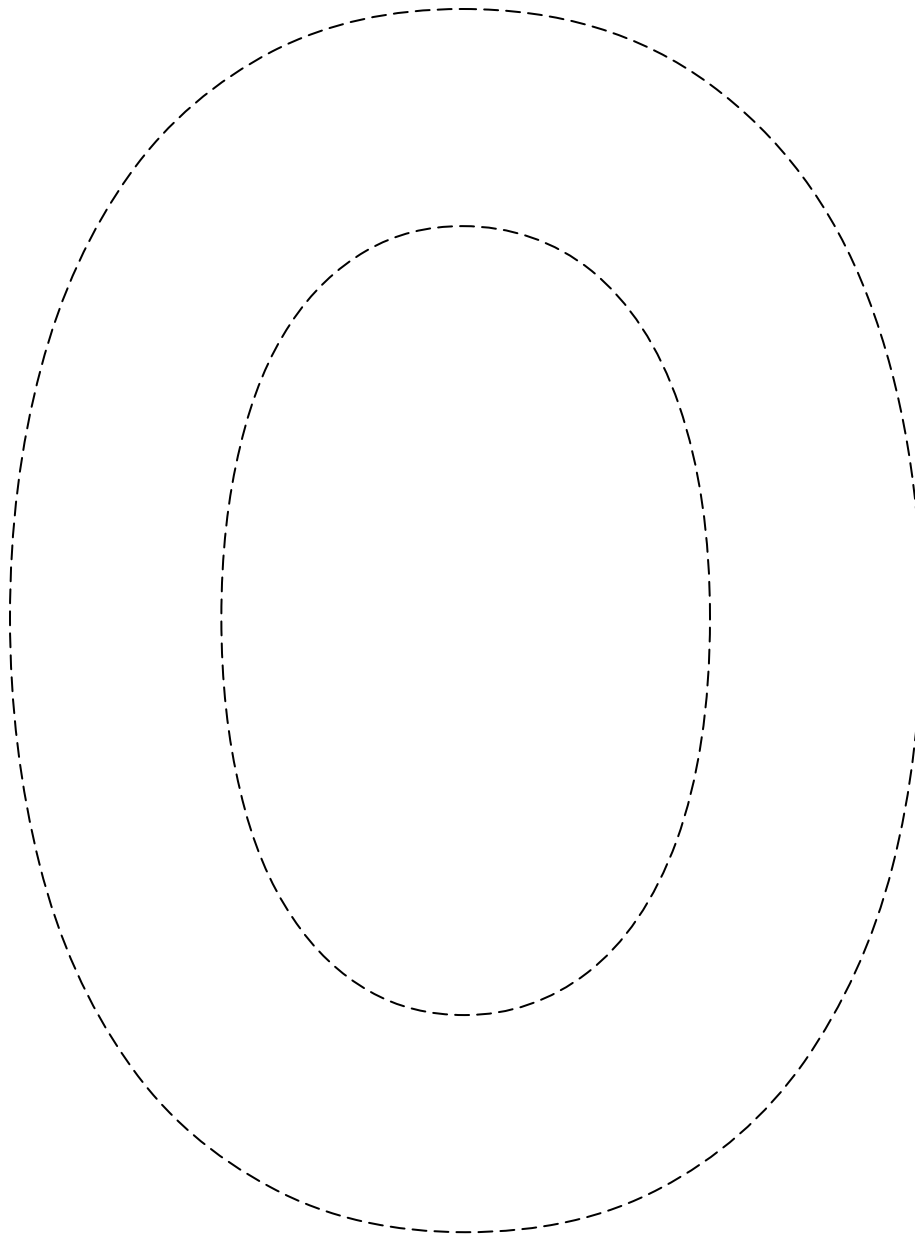

Name: _____

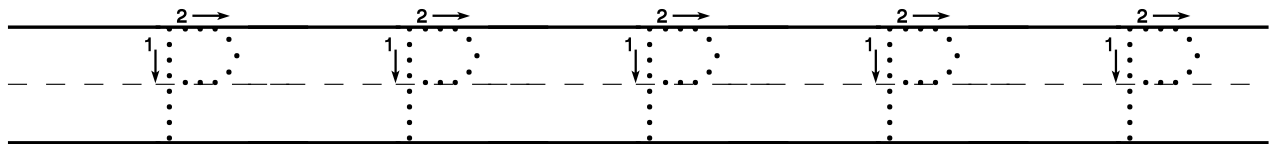
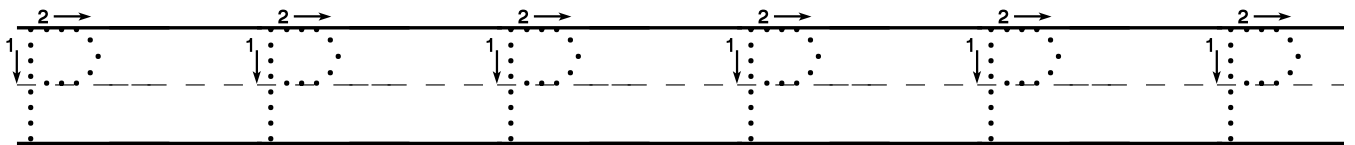
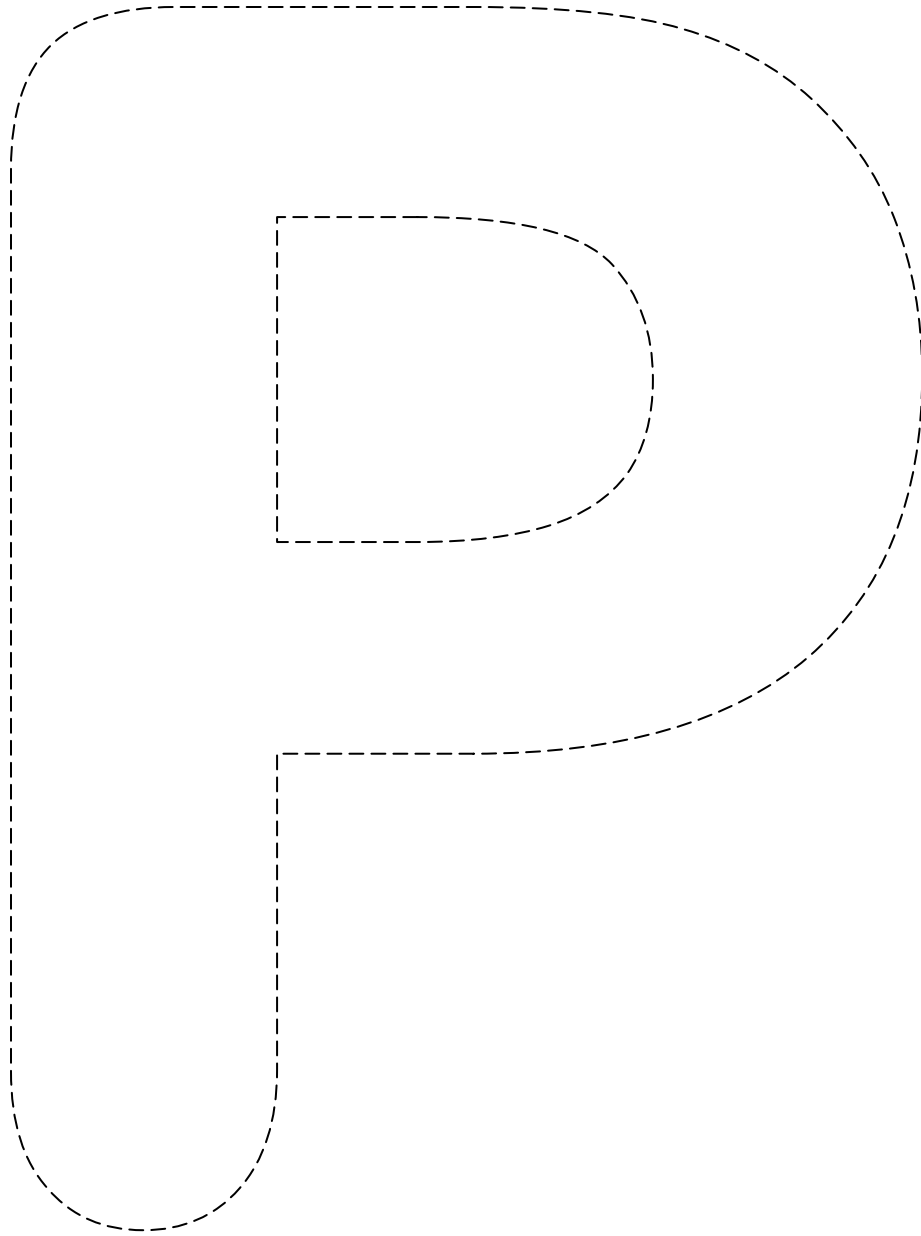

Name: _____

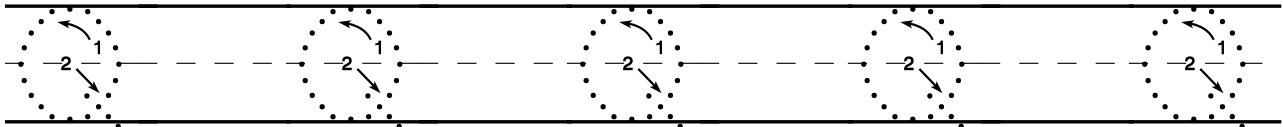
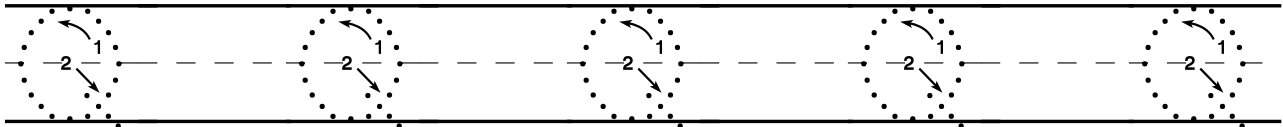
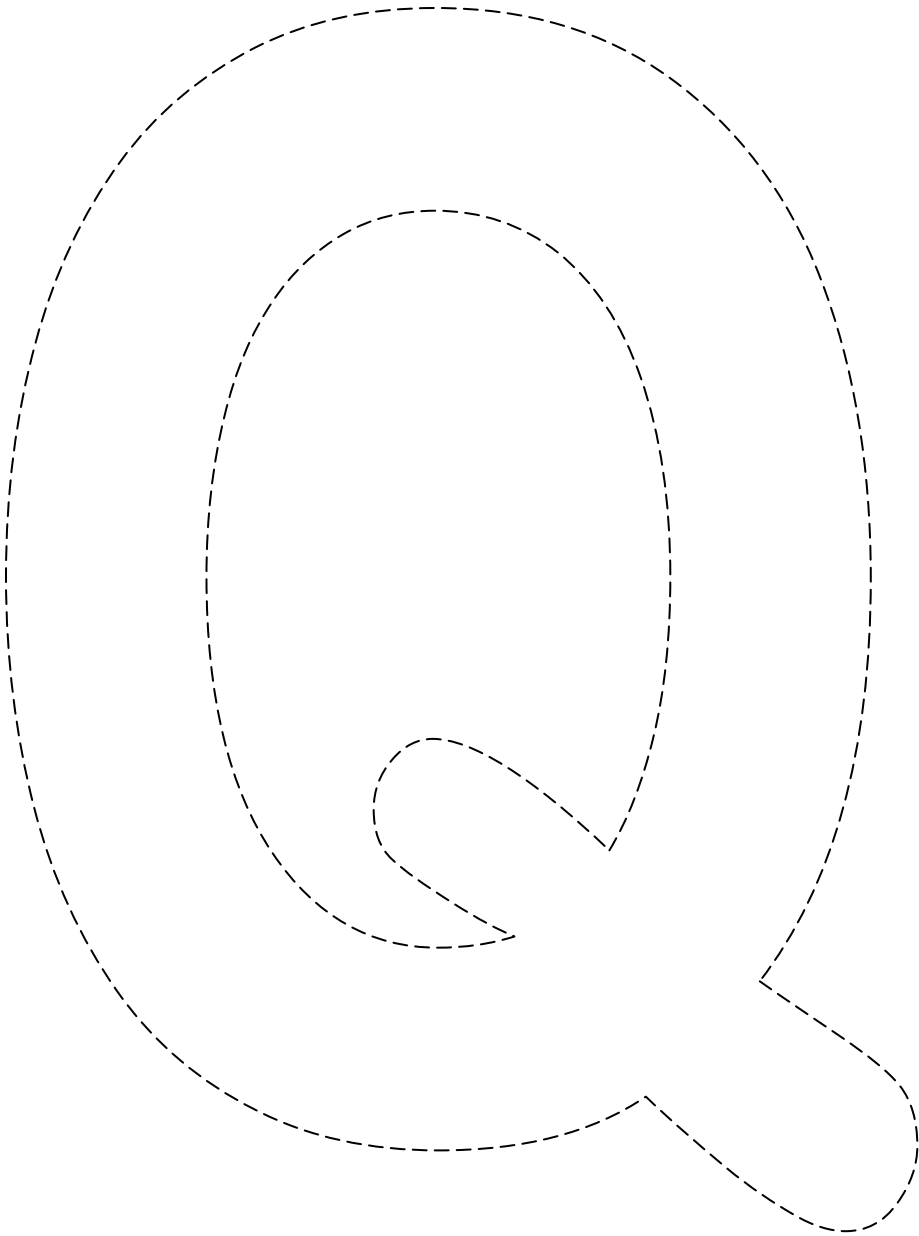

Name: _____

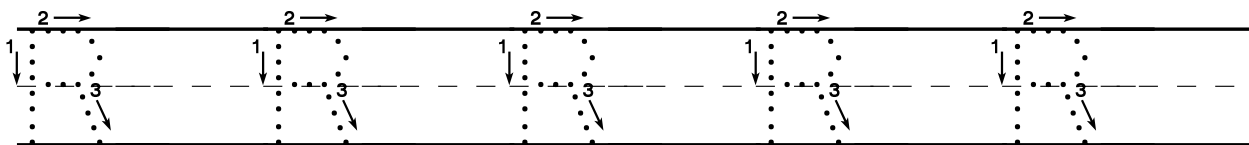
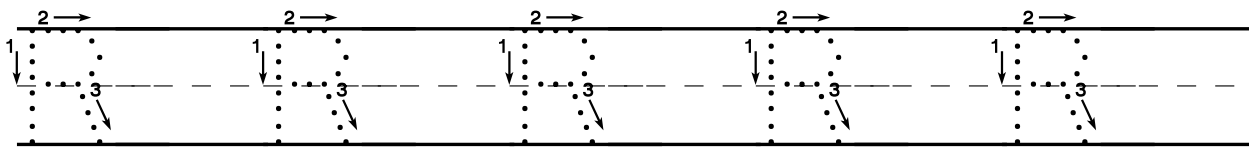
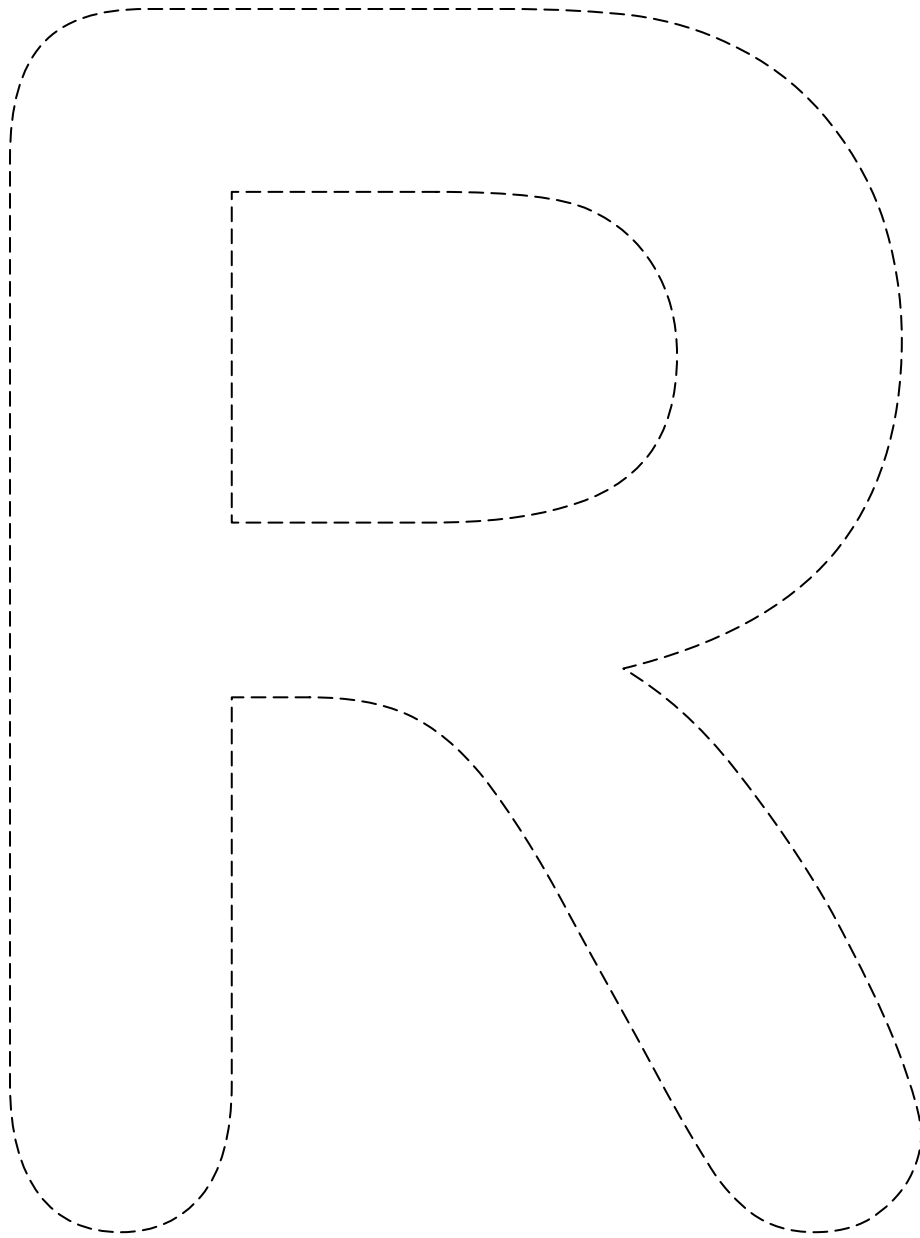

Name: _____

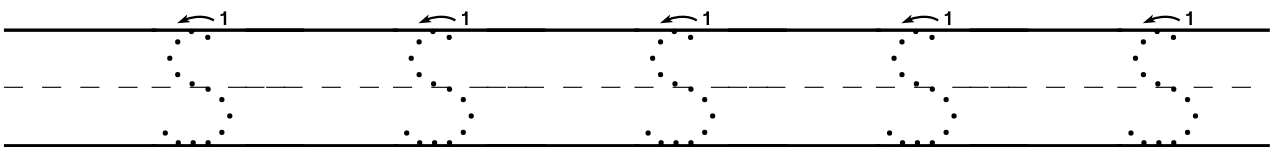
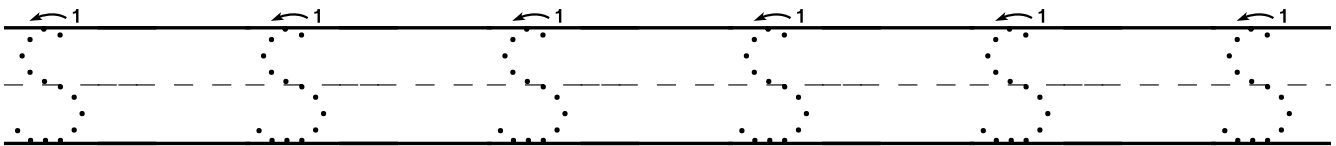
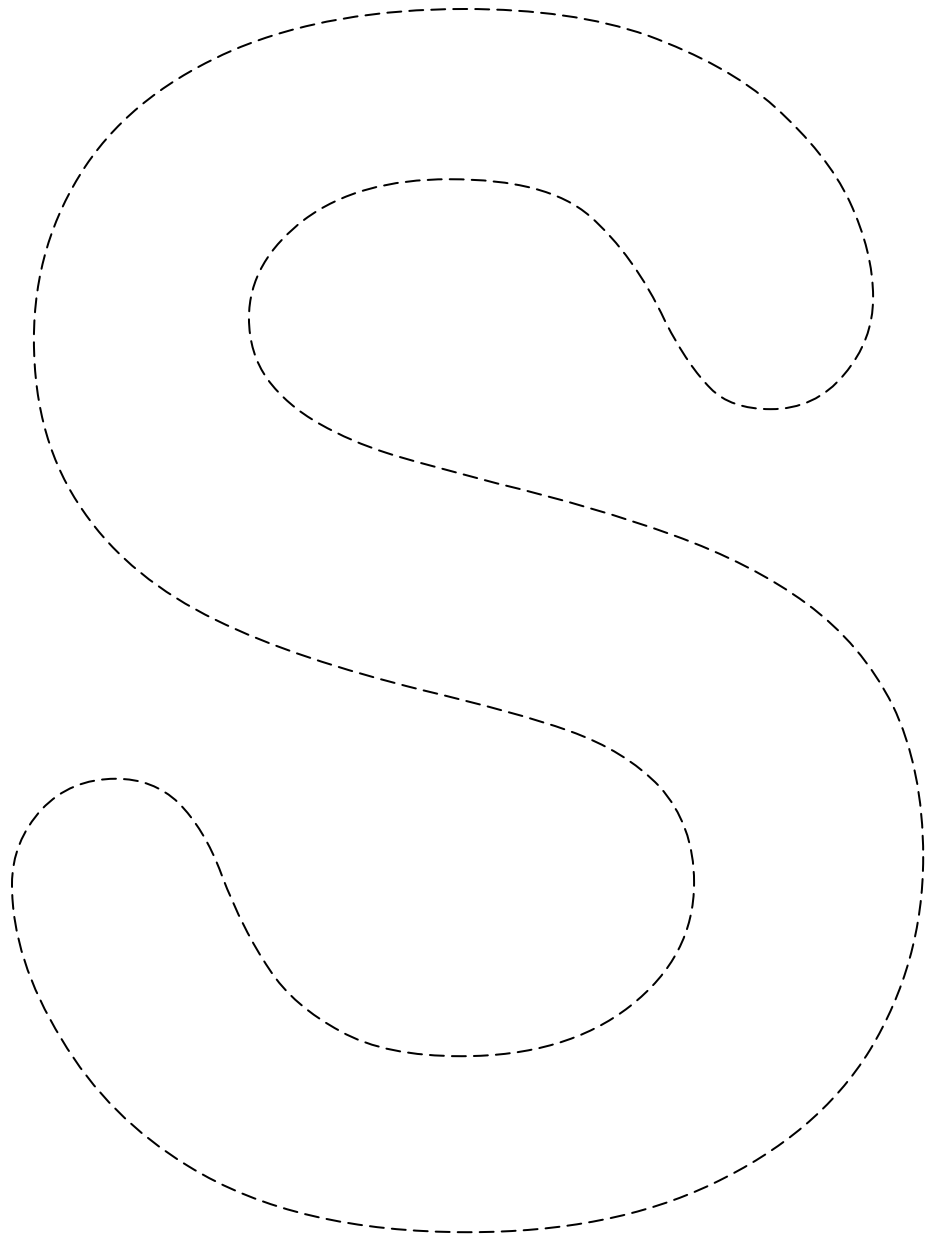

Name: _____

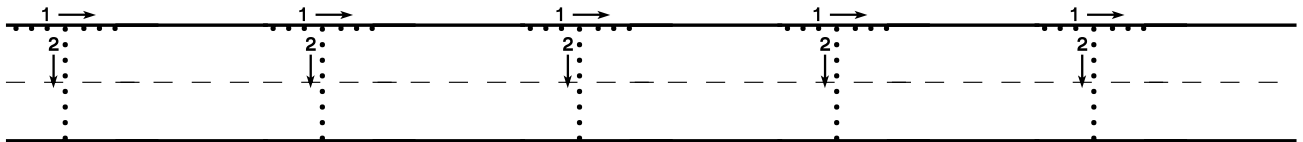
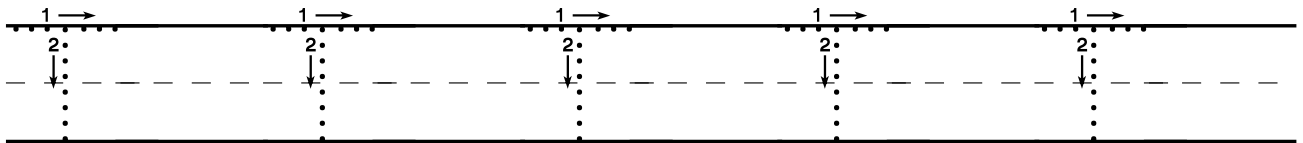
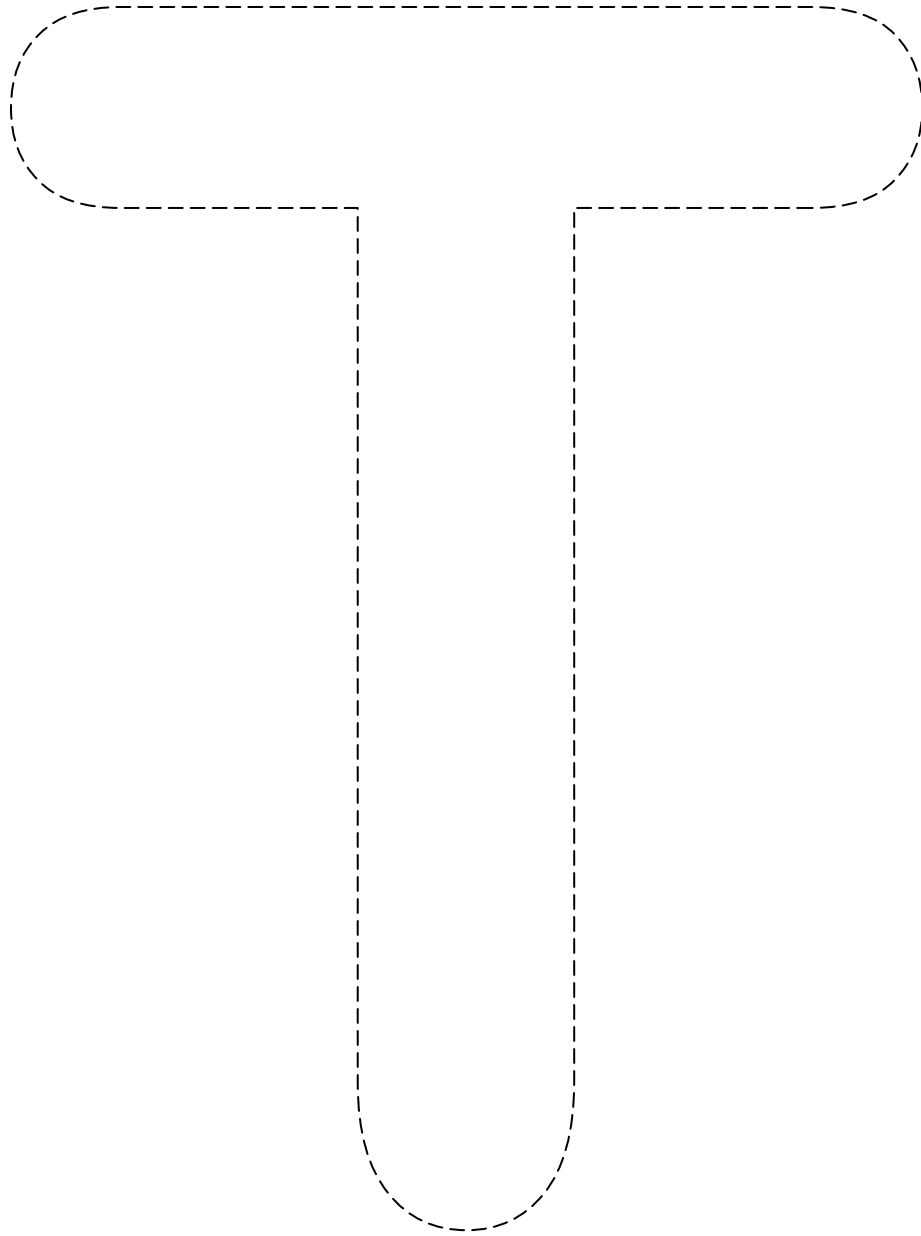

Name: _____

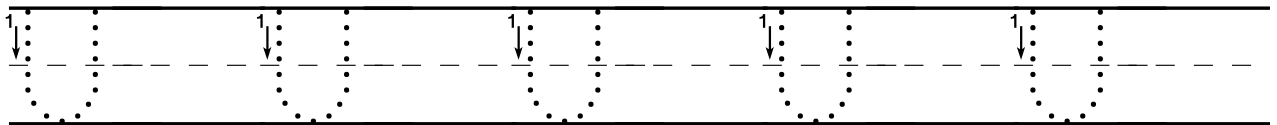
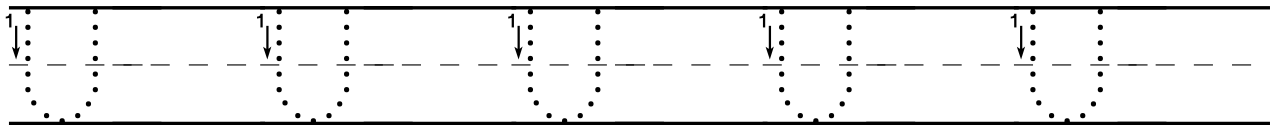
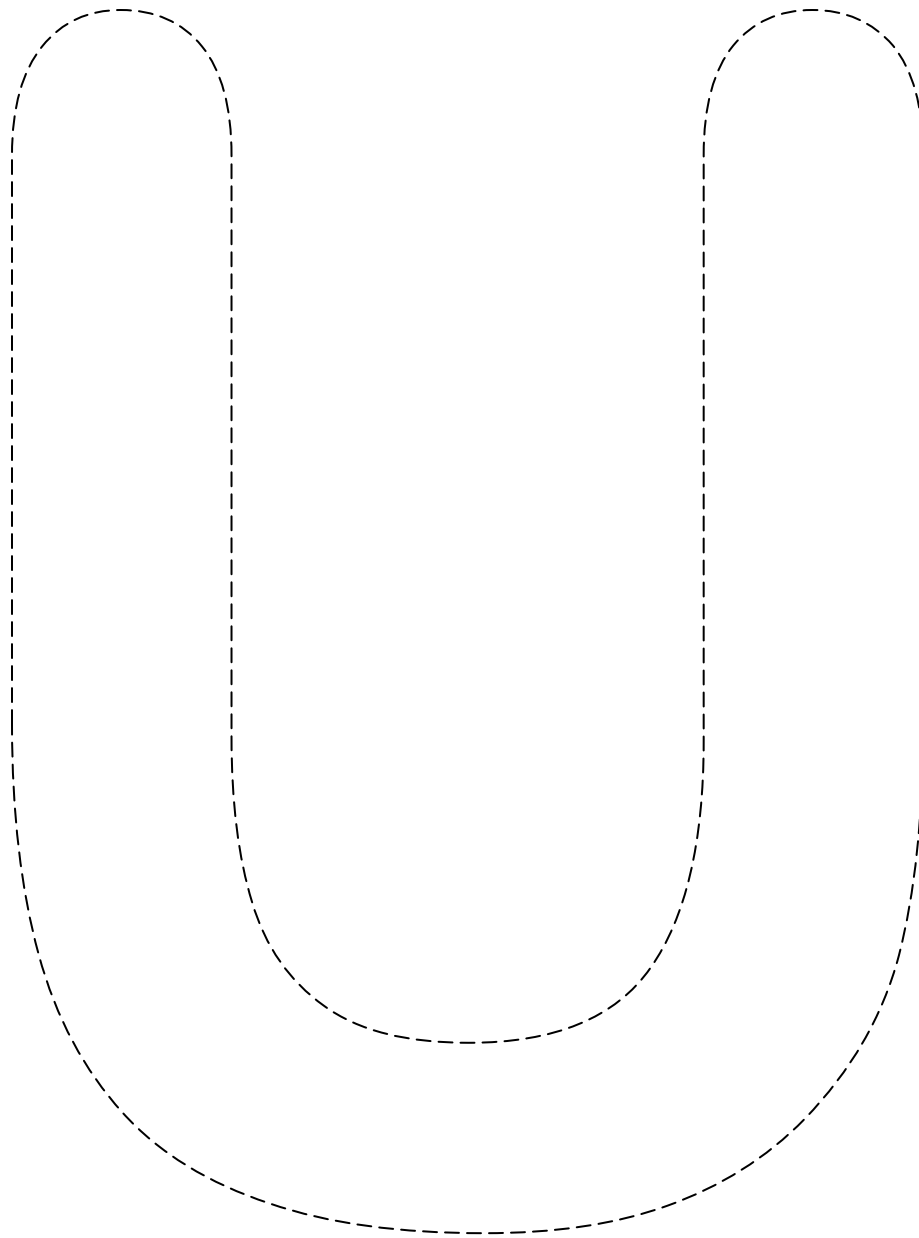

Name: _____

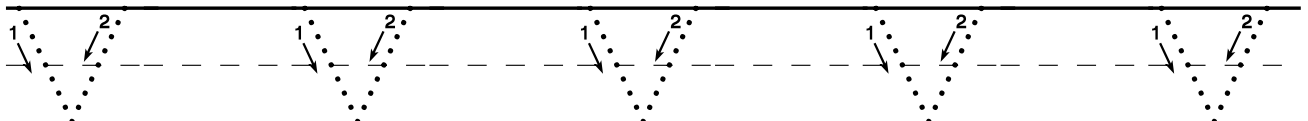
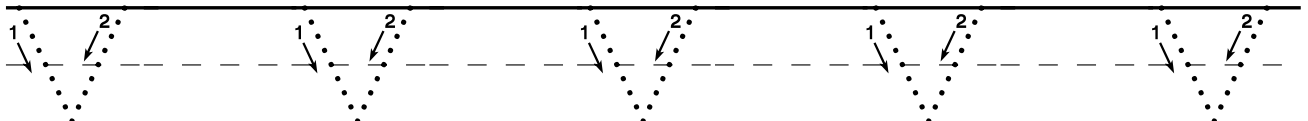
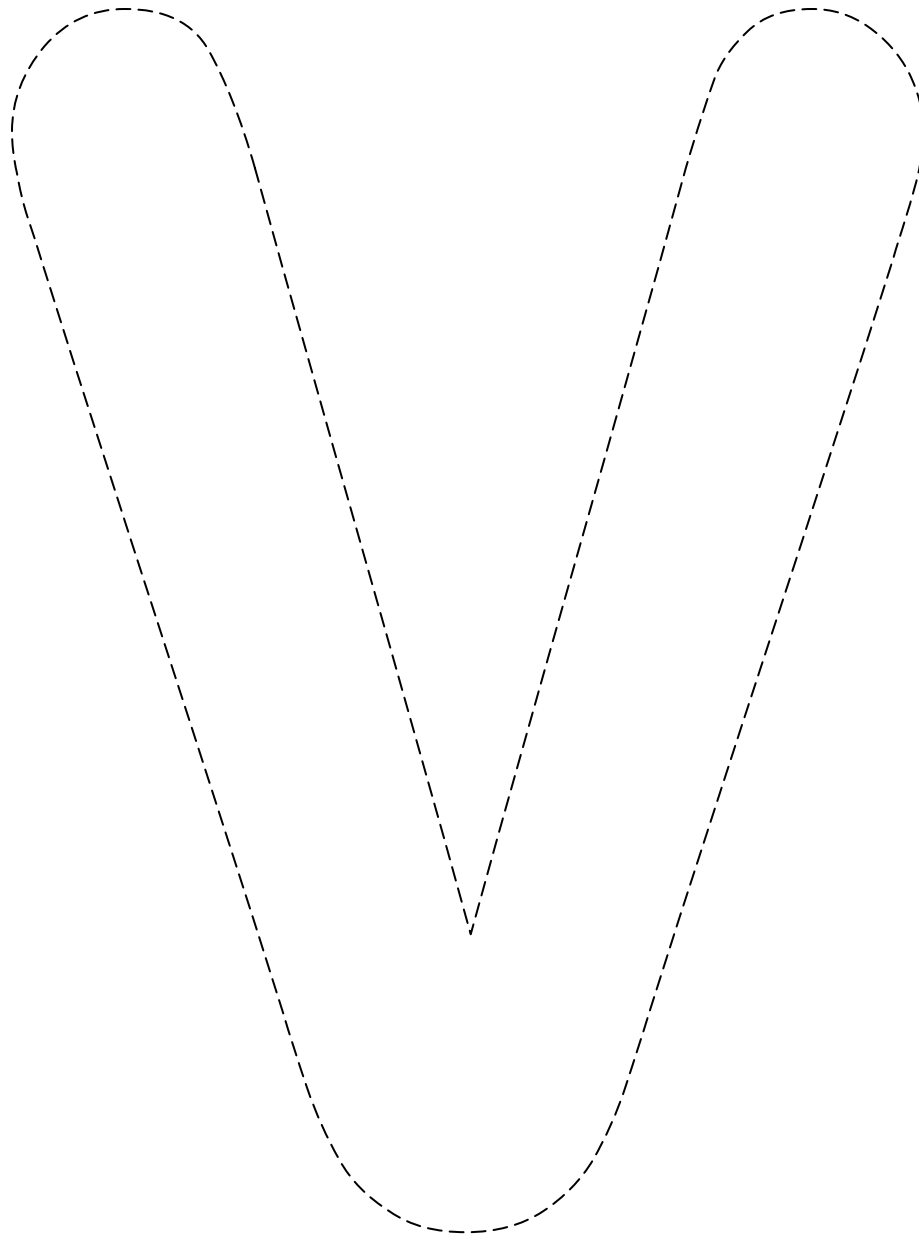

Name: _____

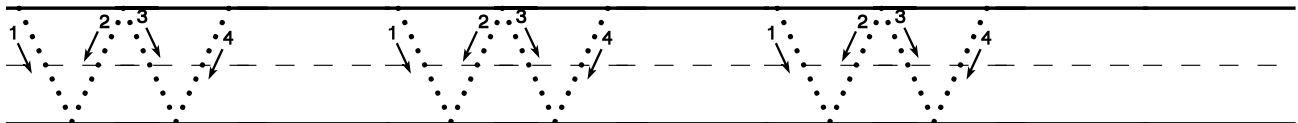
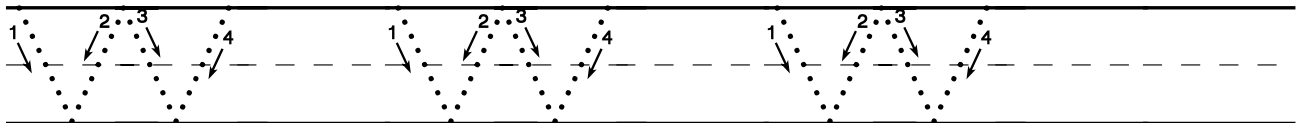
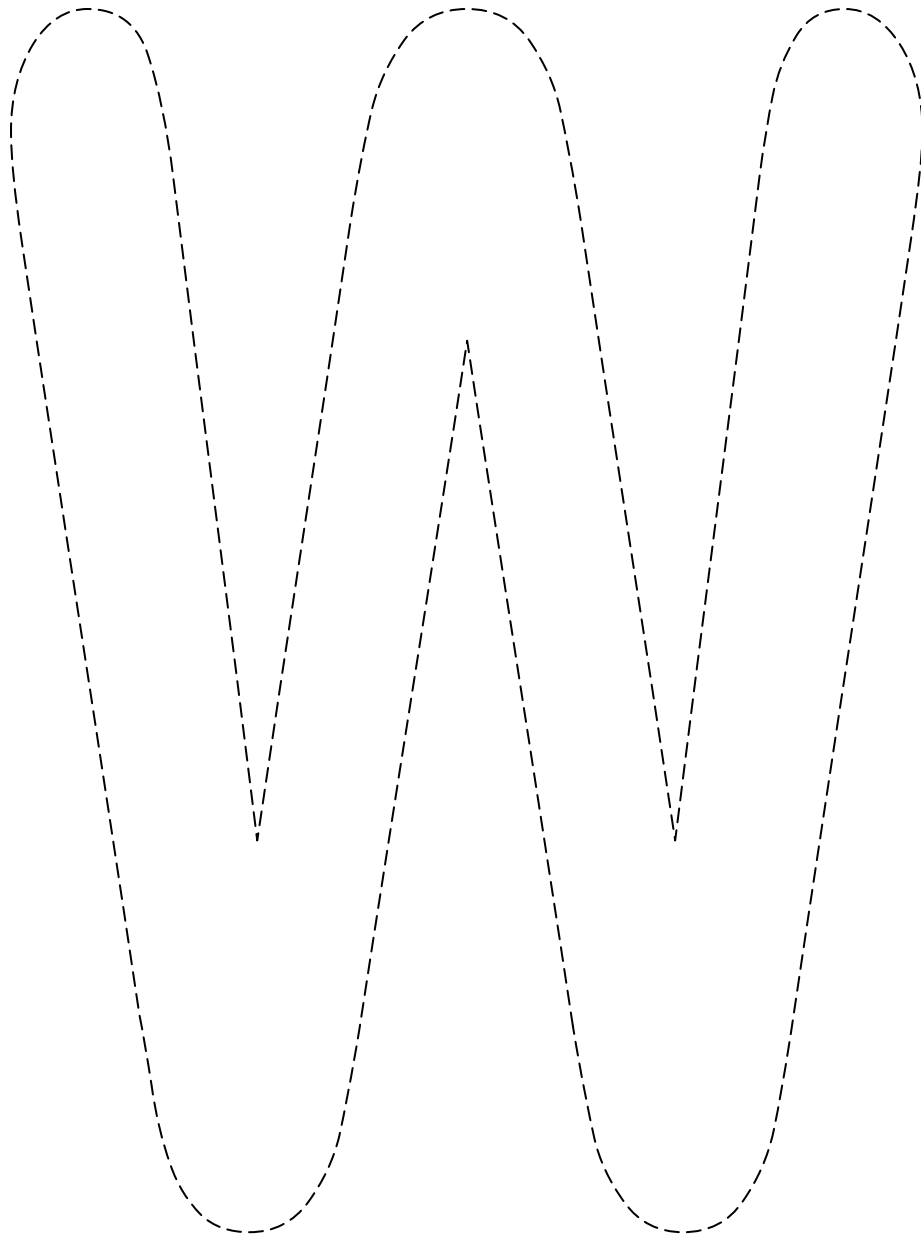

Name: _____

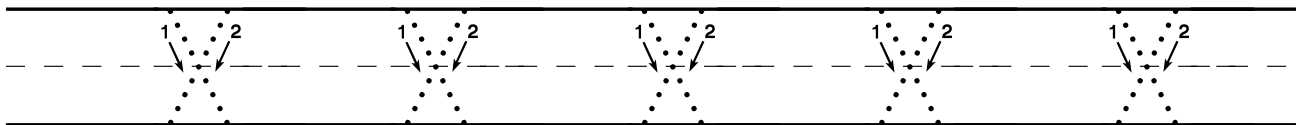
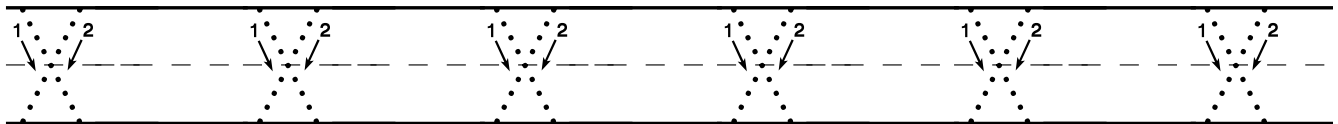
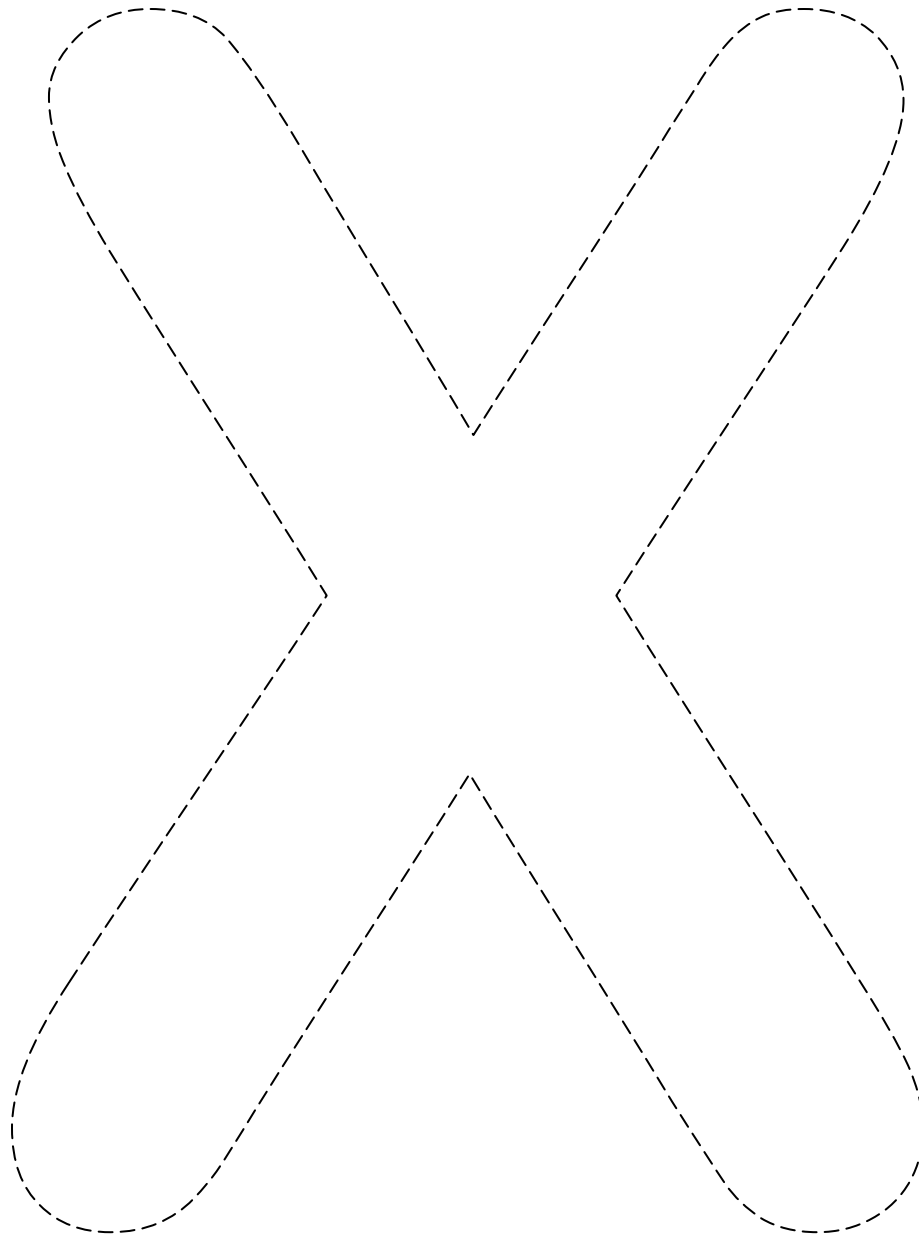

Name: _____

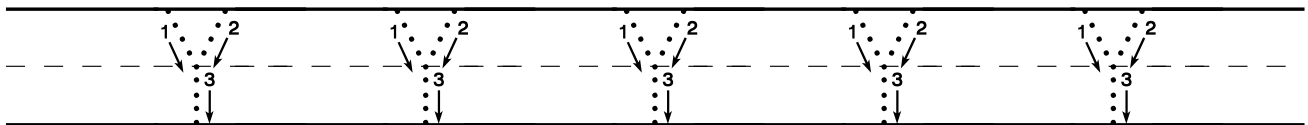
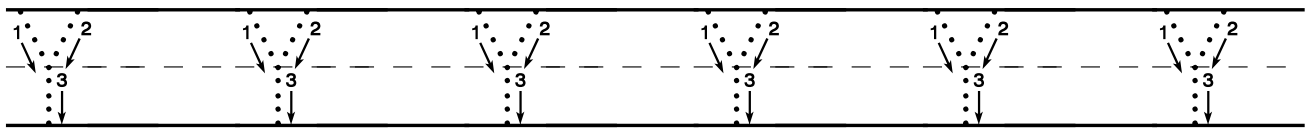
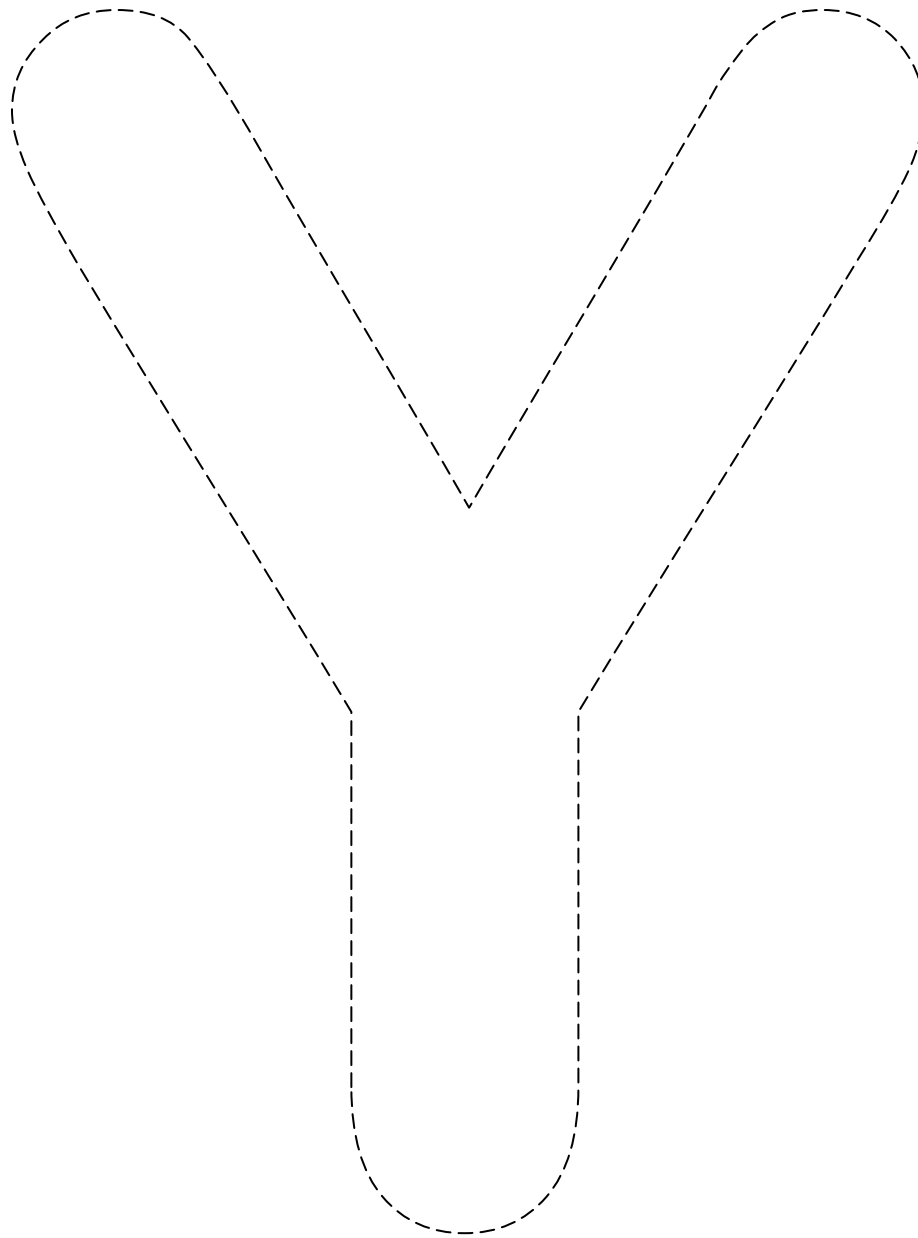

Name: _____

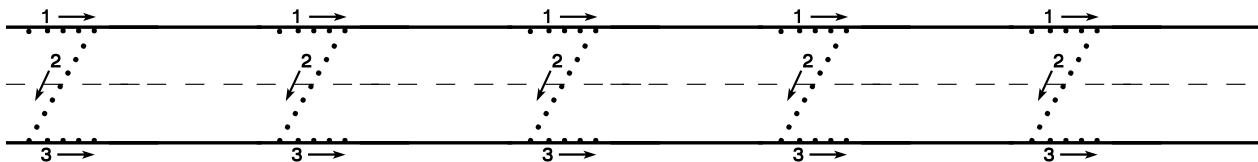
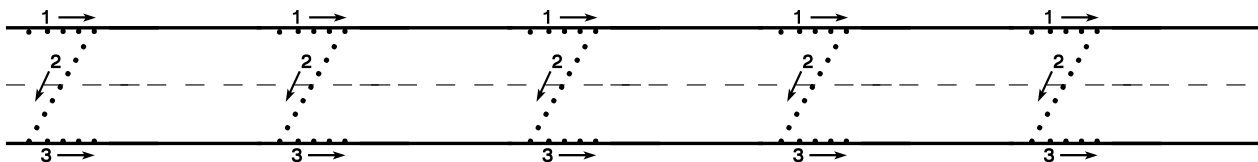
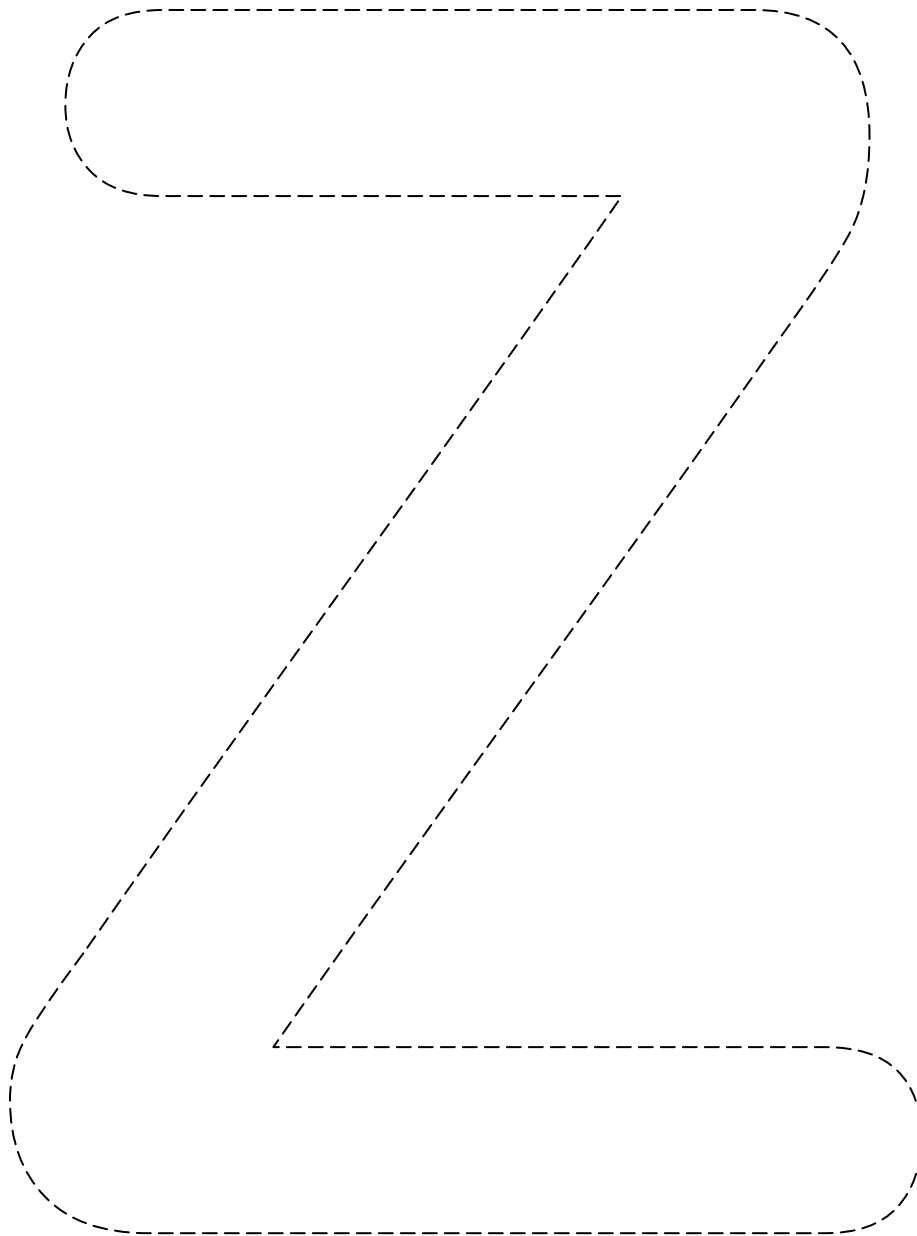

Name: _____

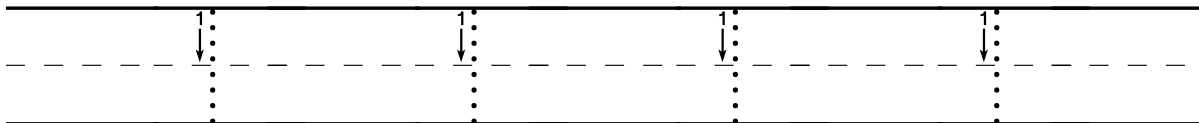
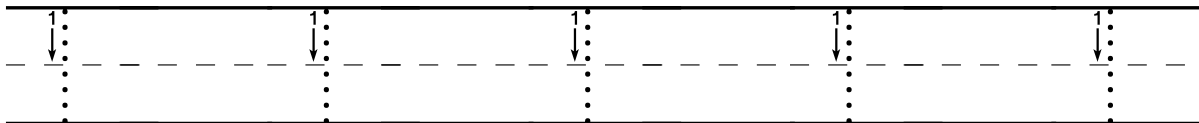
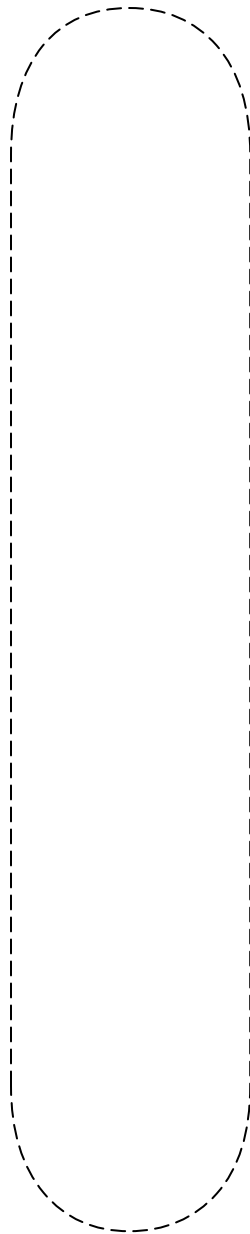

Name: _____

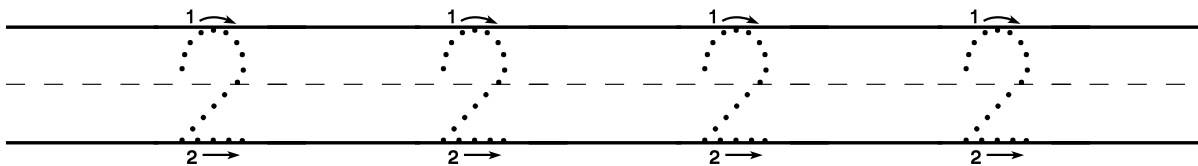
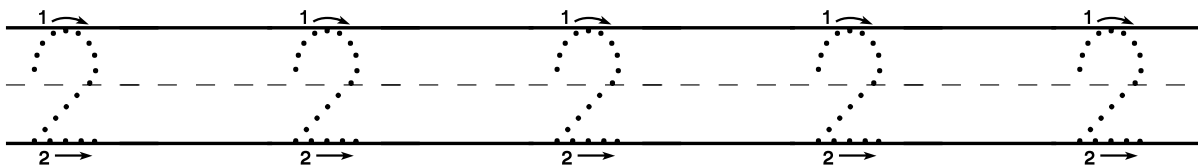
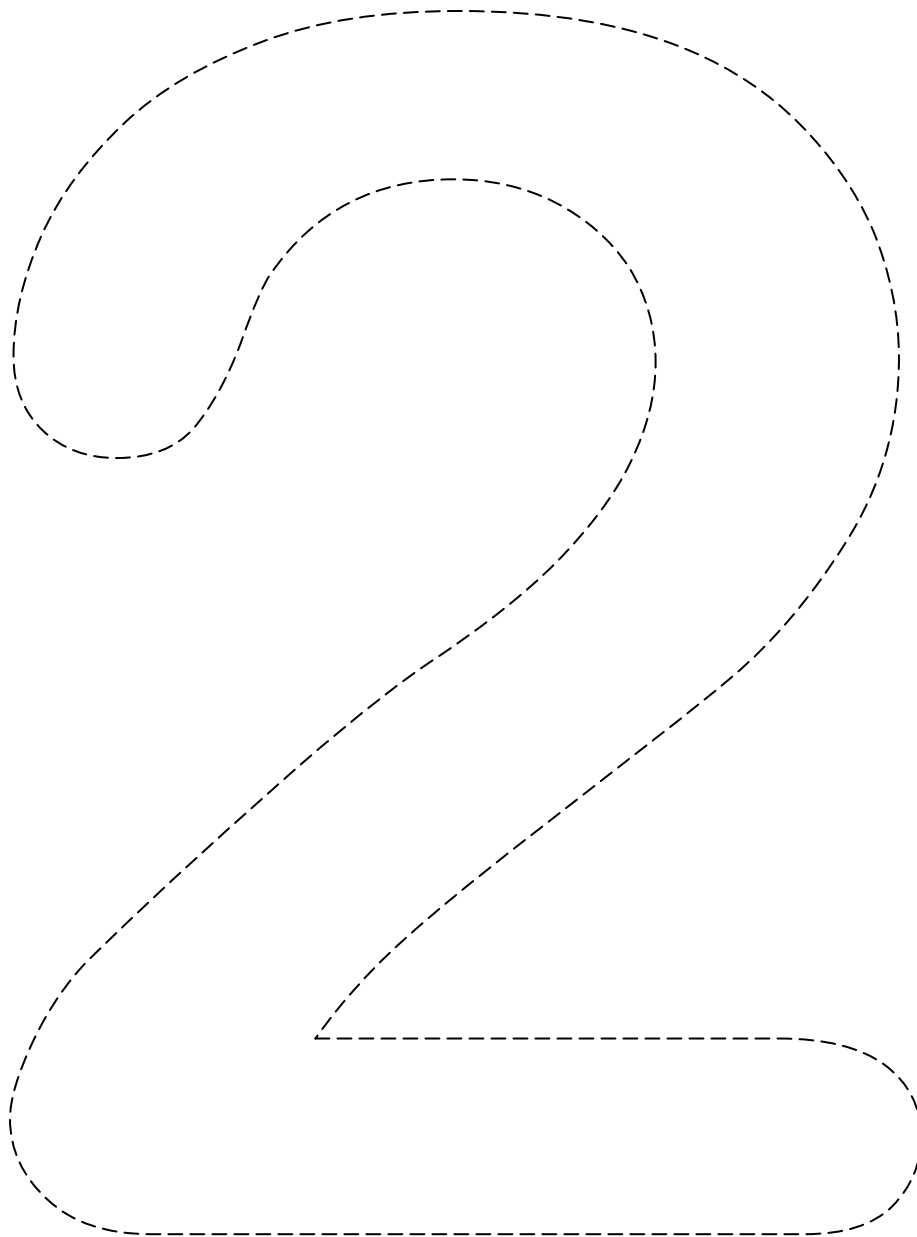

Name: _____

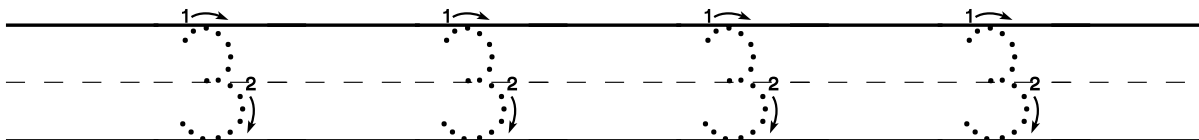
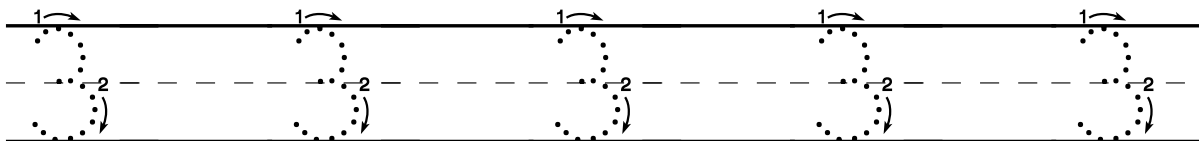
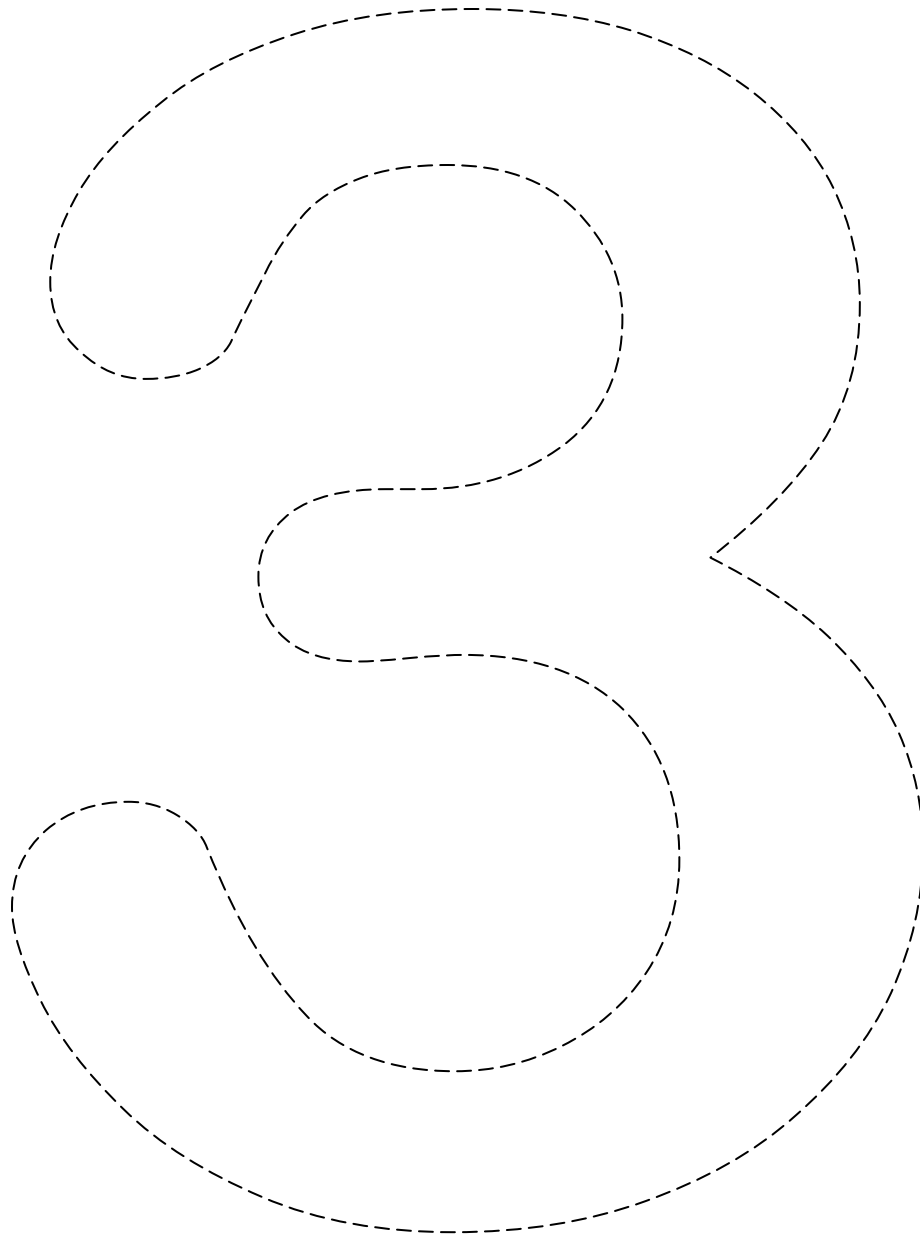

Name: _____

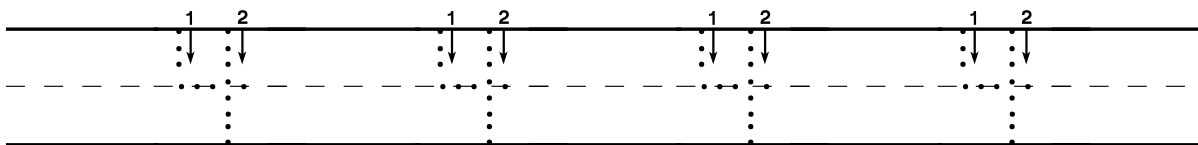
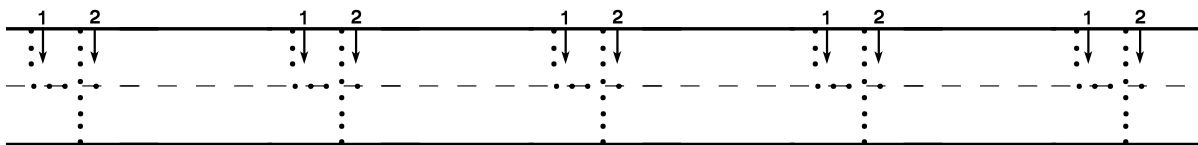
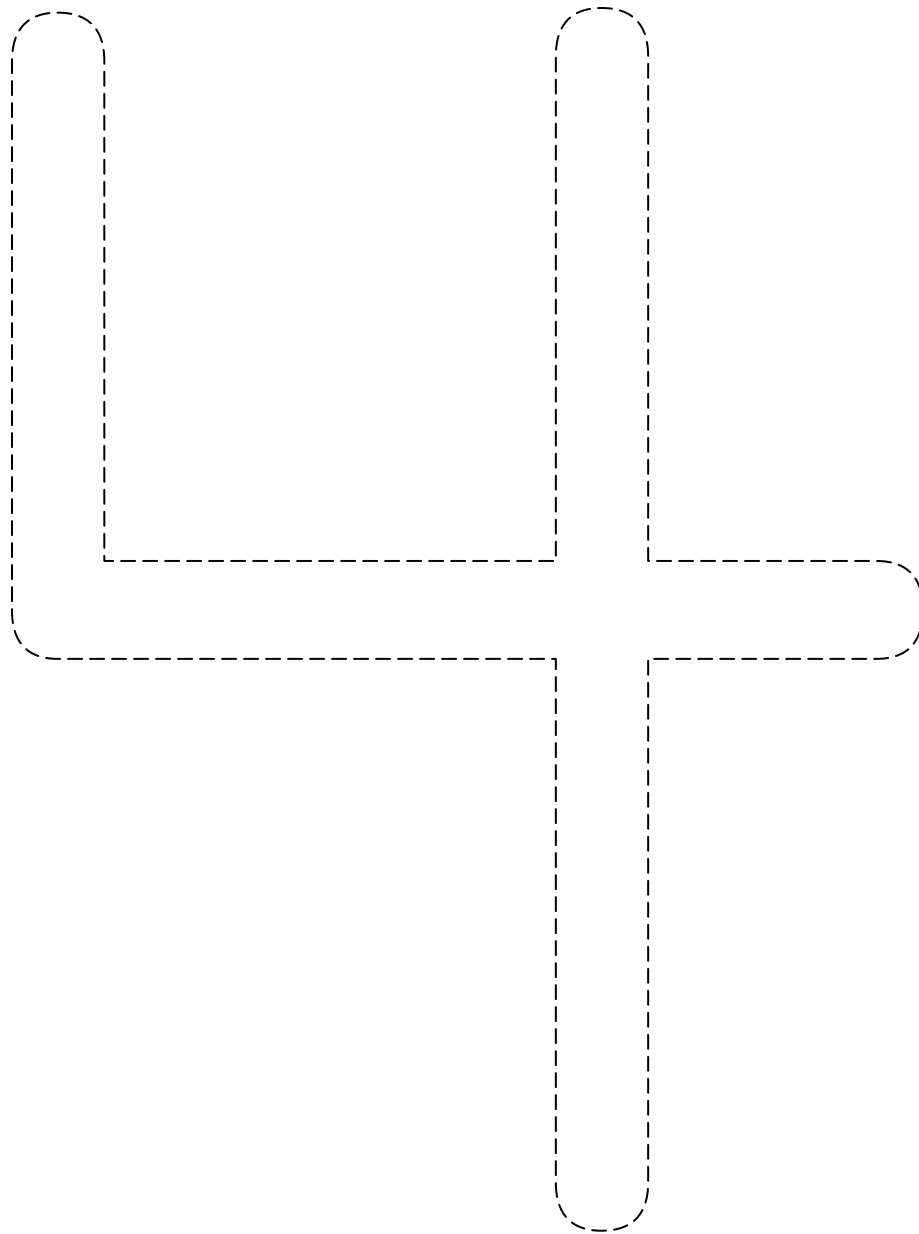

Name: _____

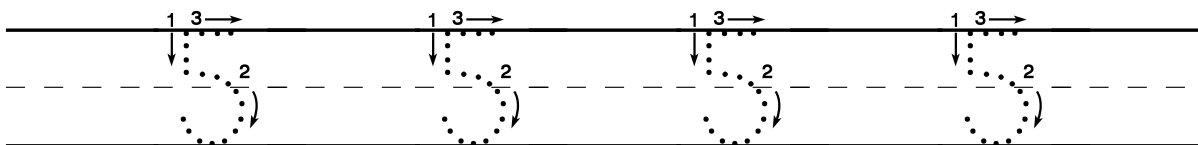
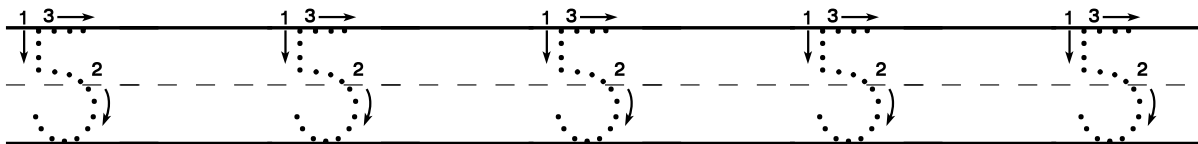
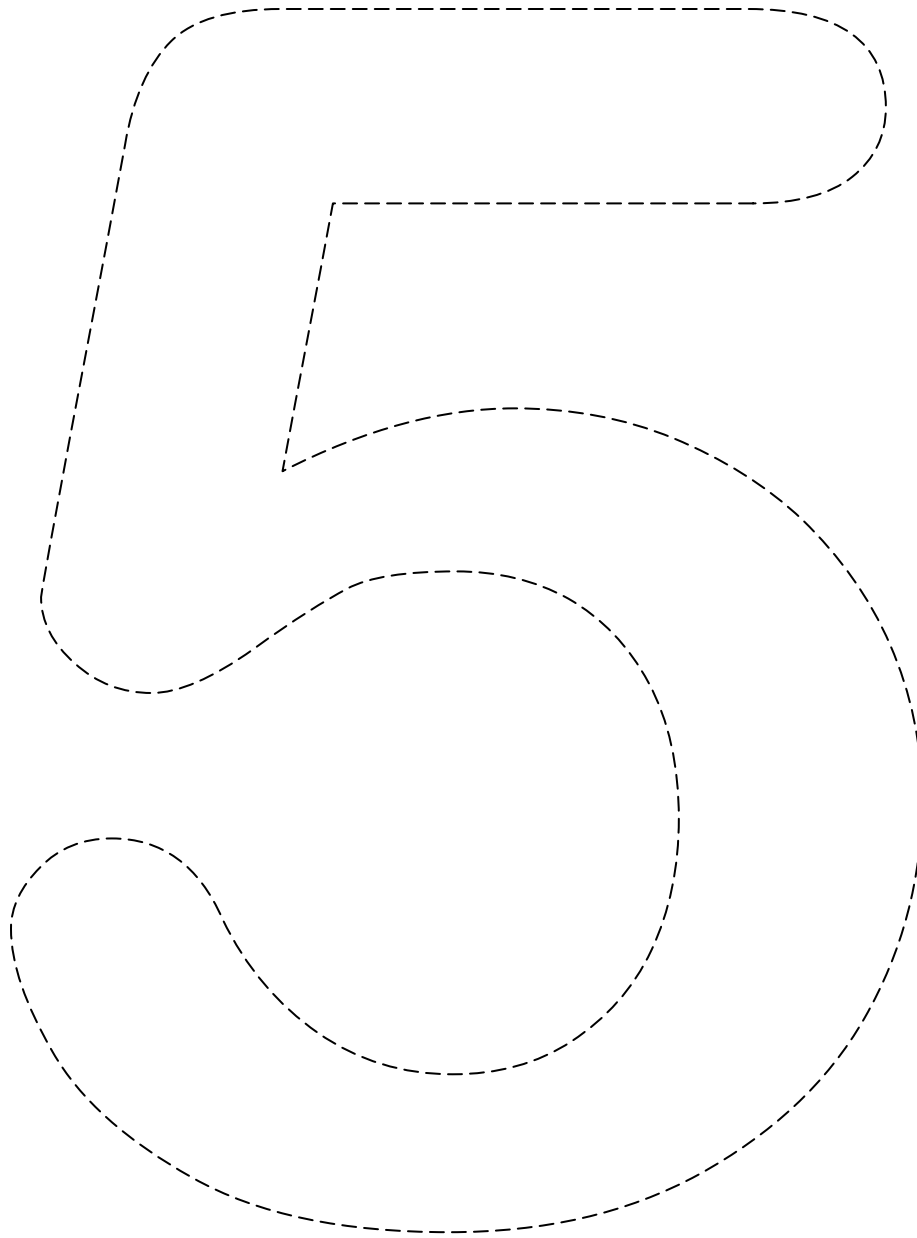

Name: _____

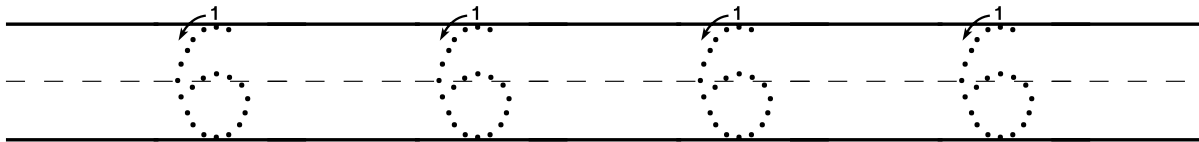
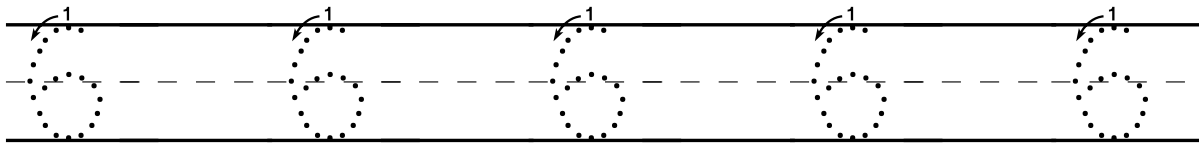
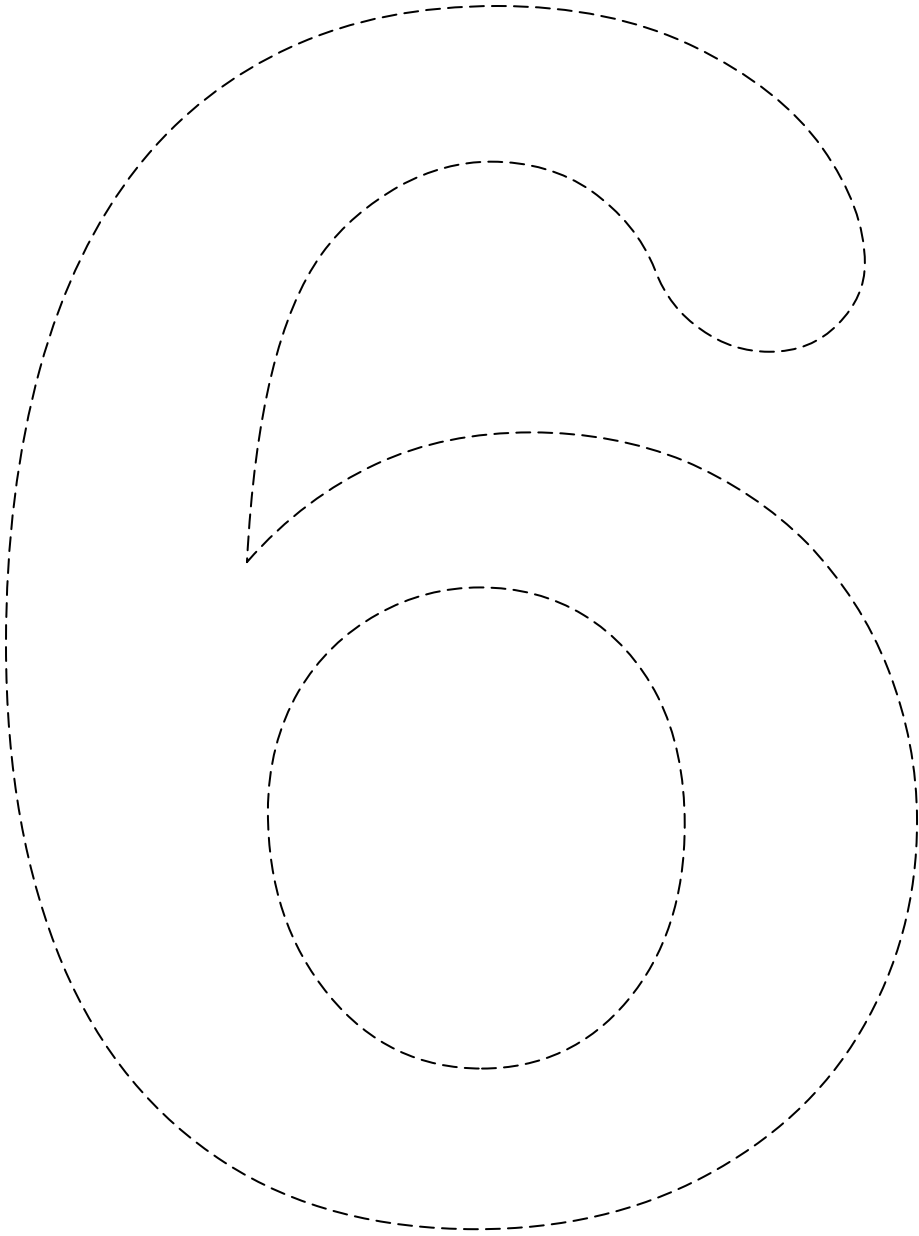

Name: _____

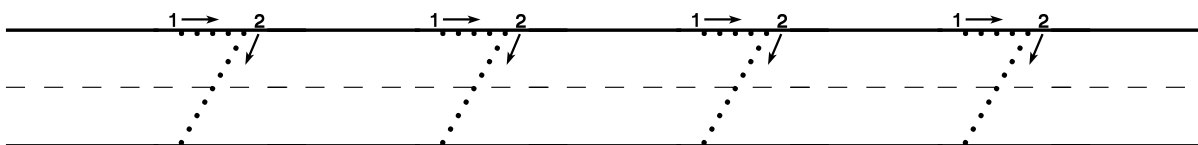
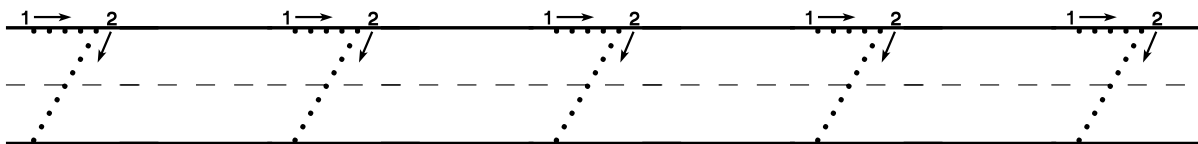
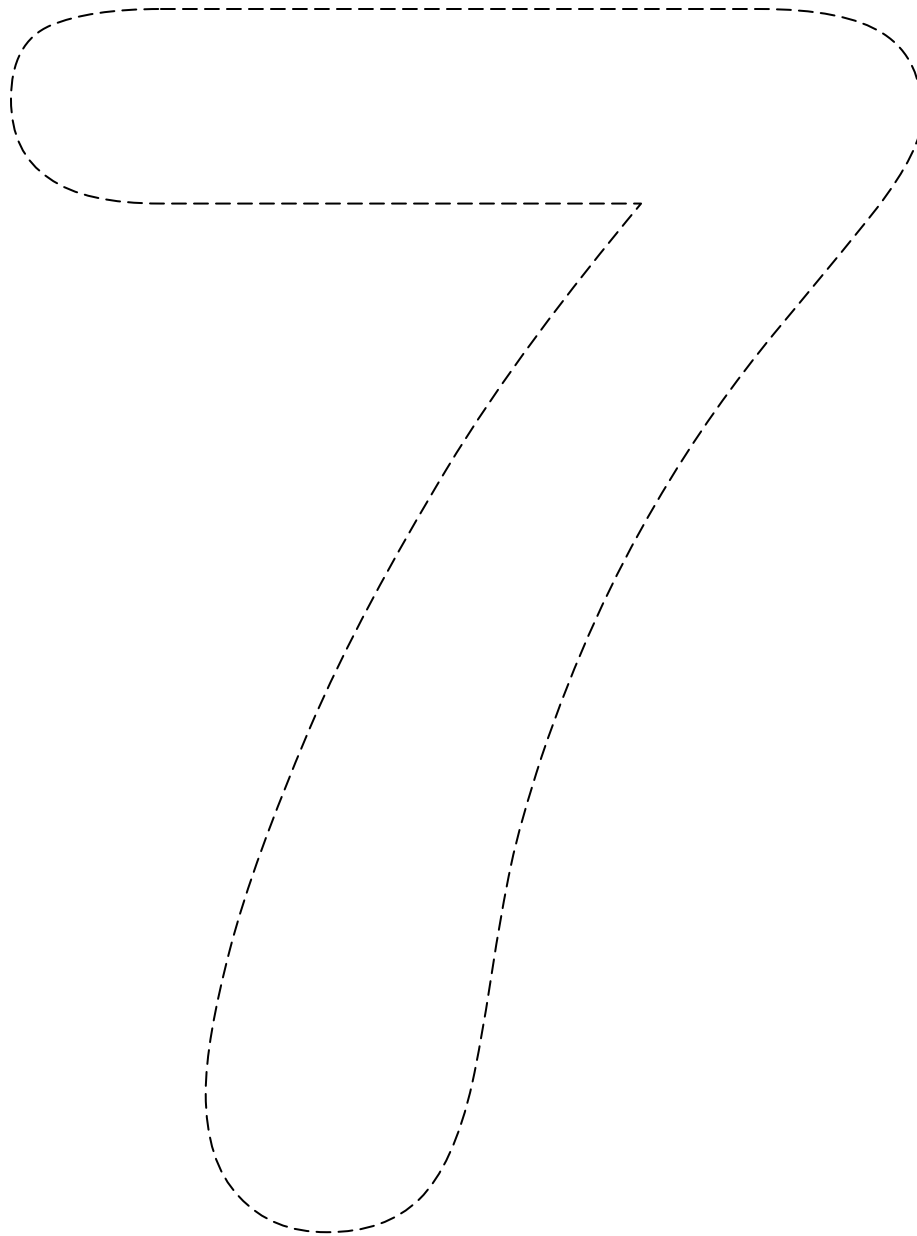

Name: _____

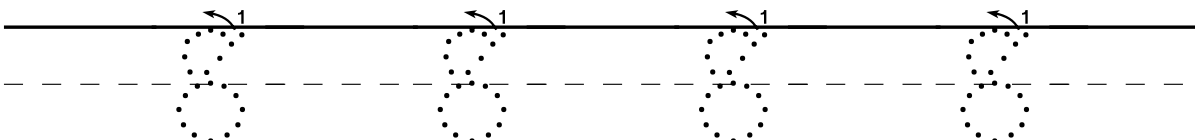
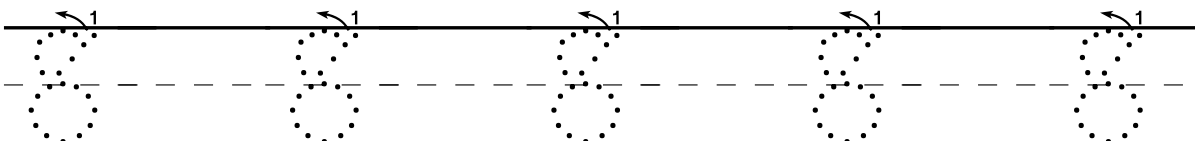
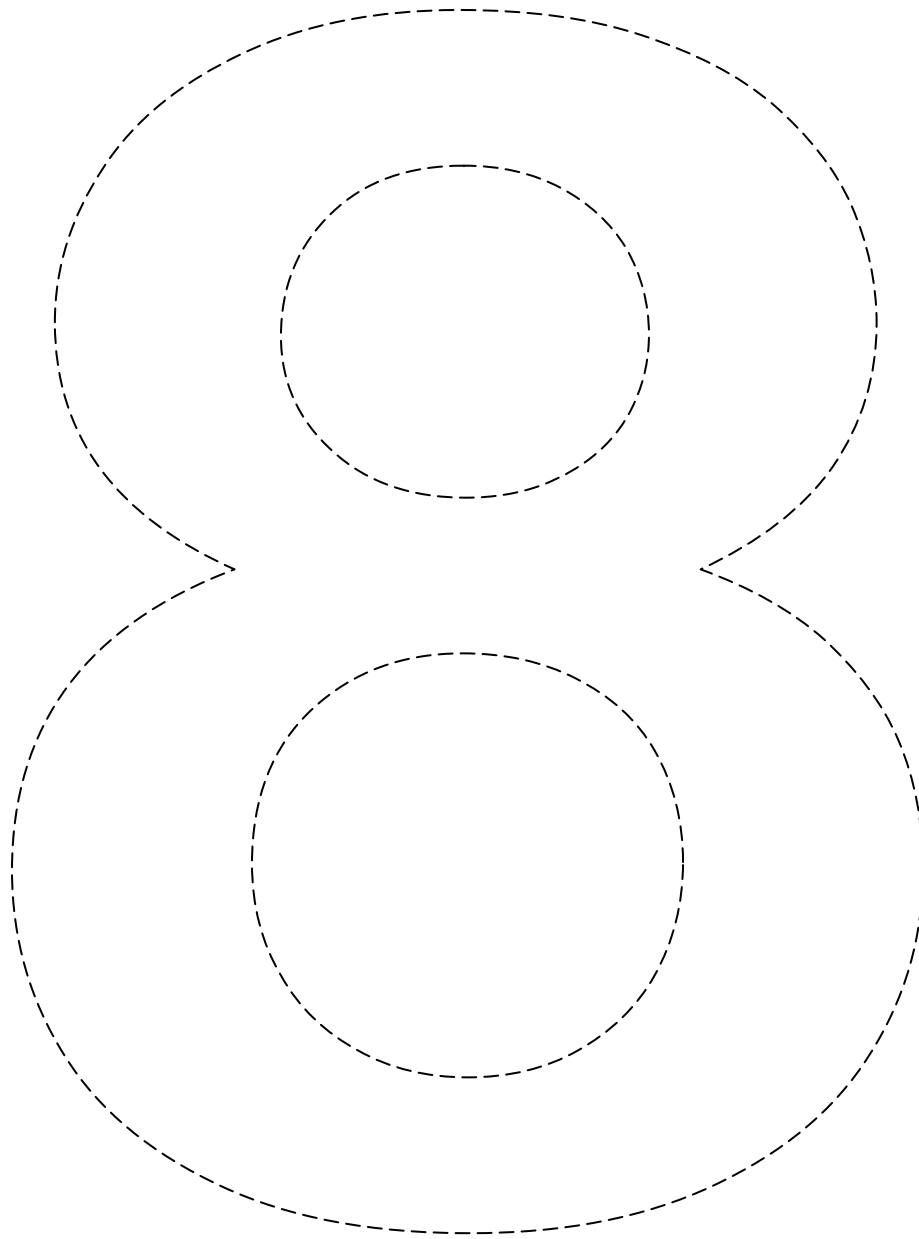

Name: _____

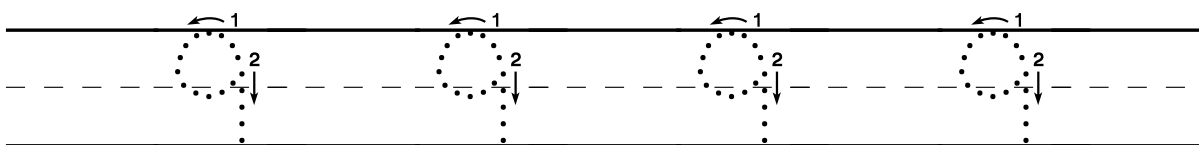
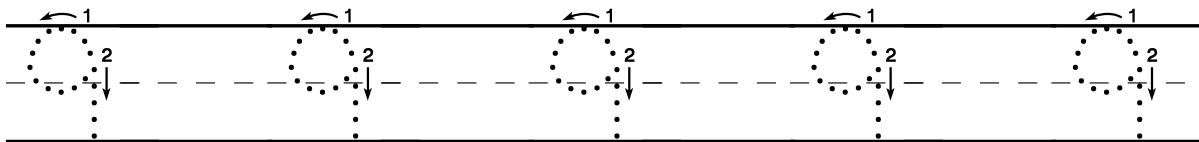
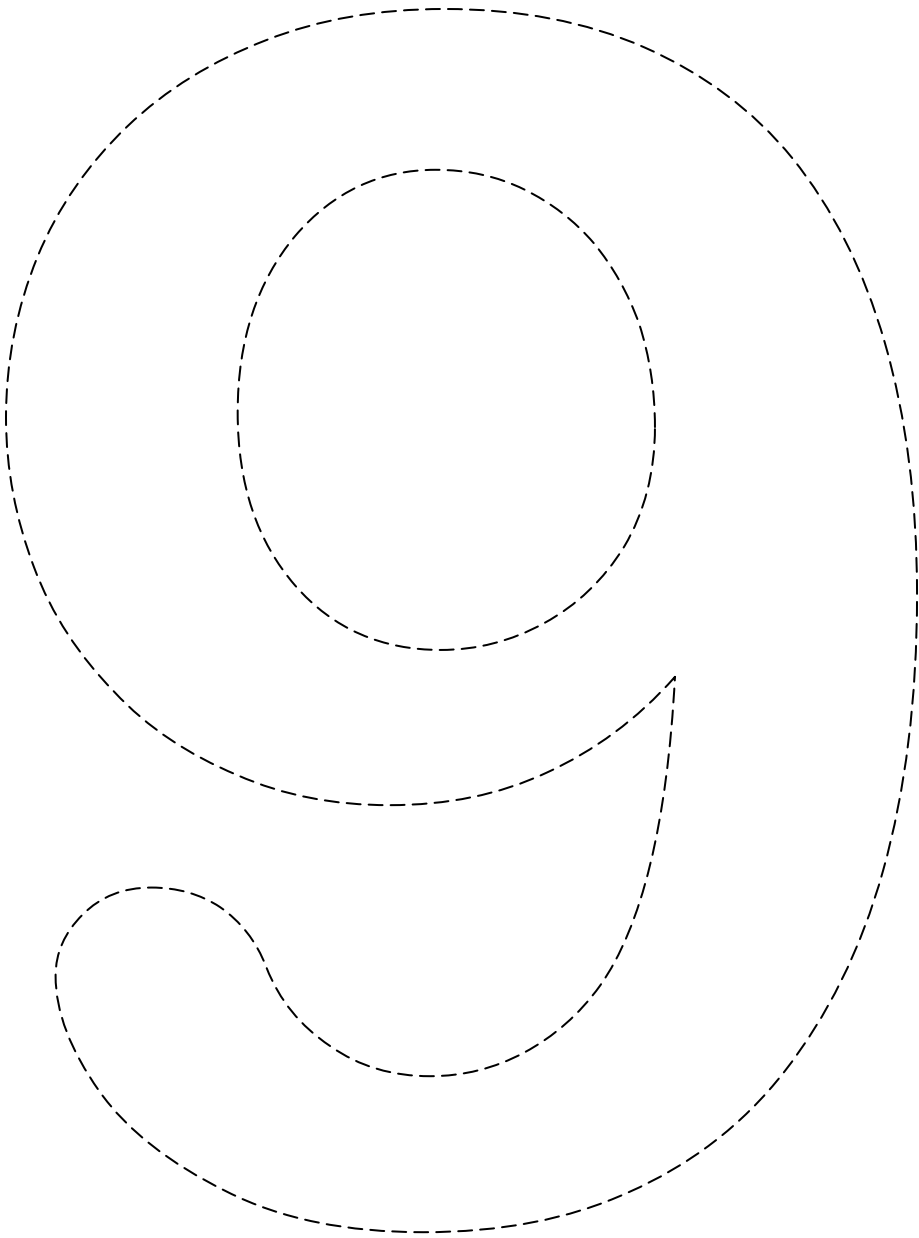

Name: _____

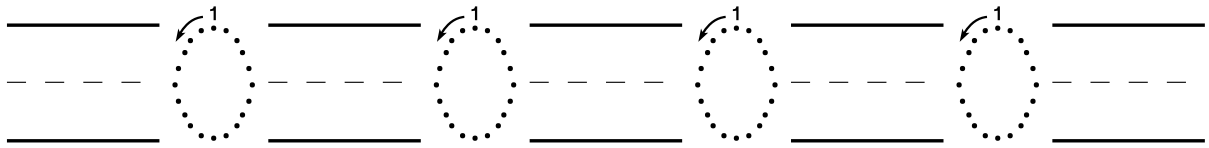
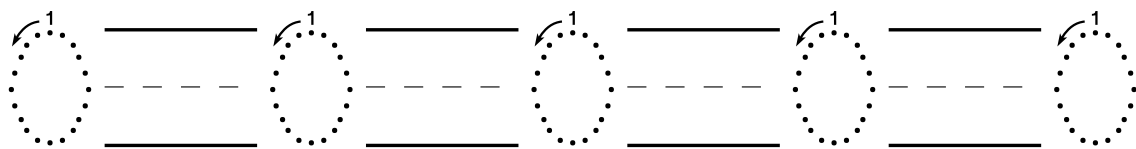
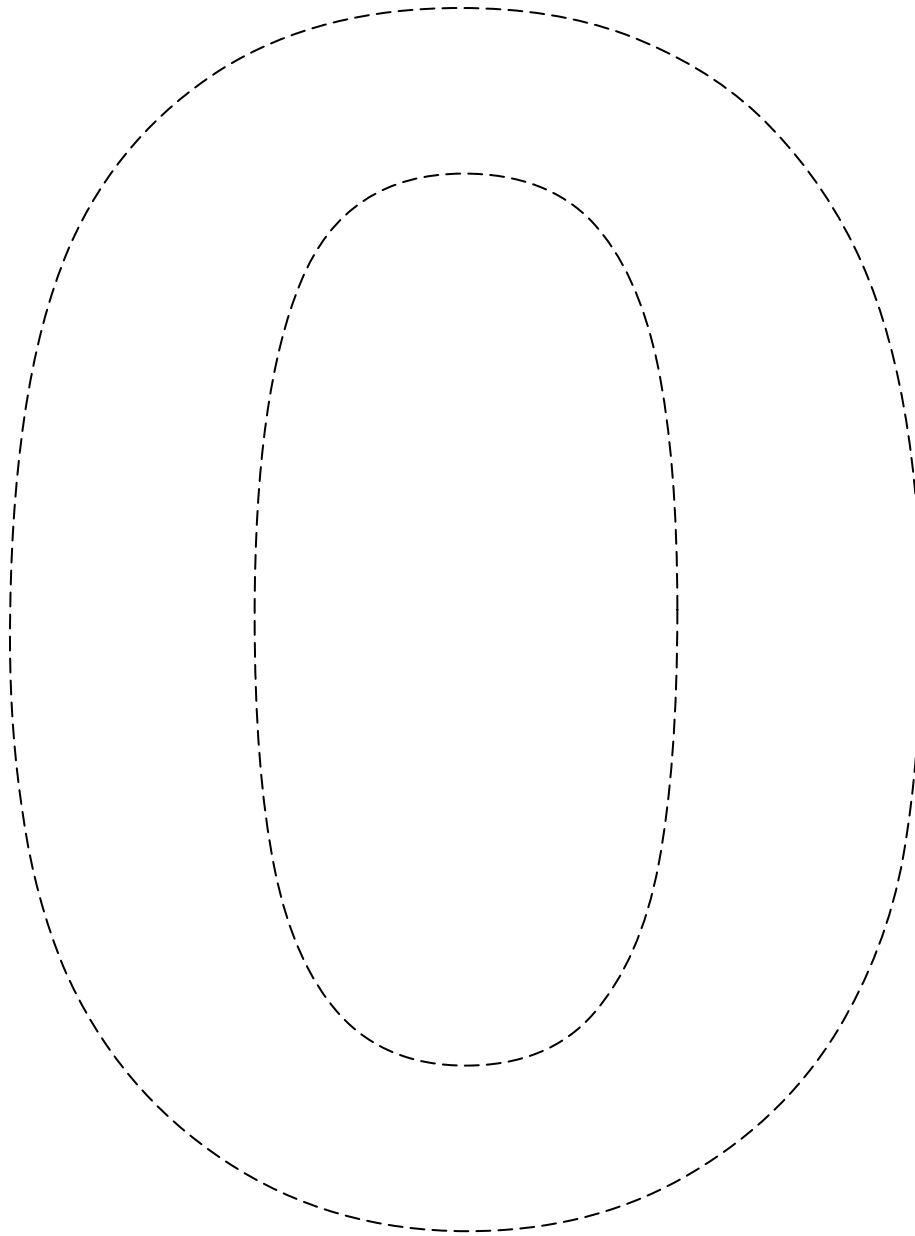

Name: _____

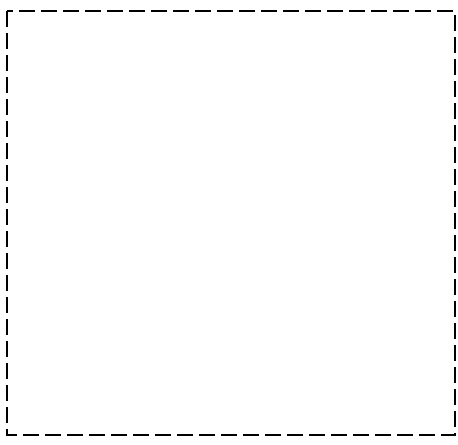
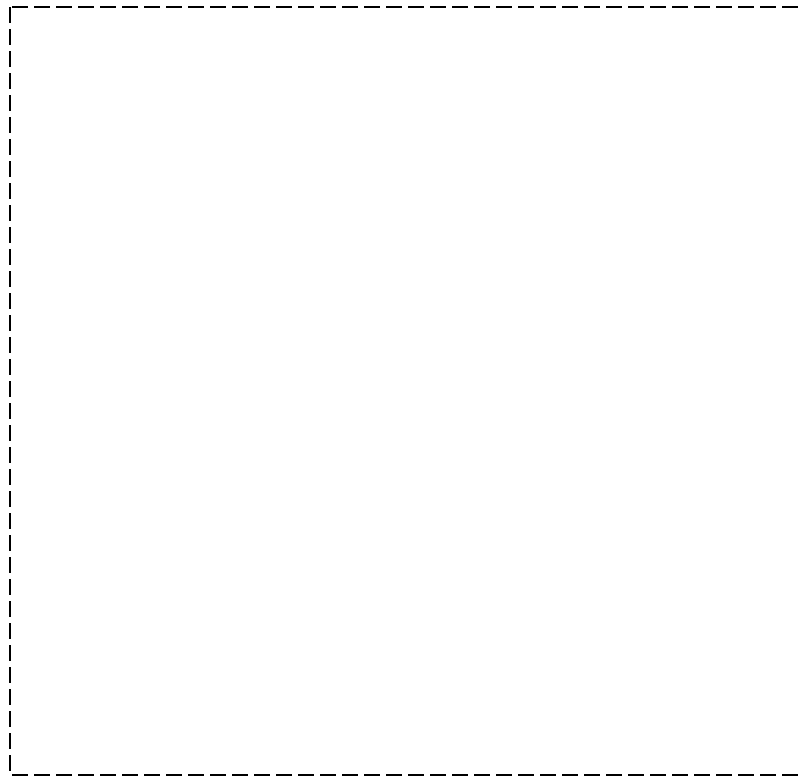

square

Name: _____

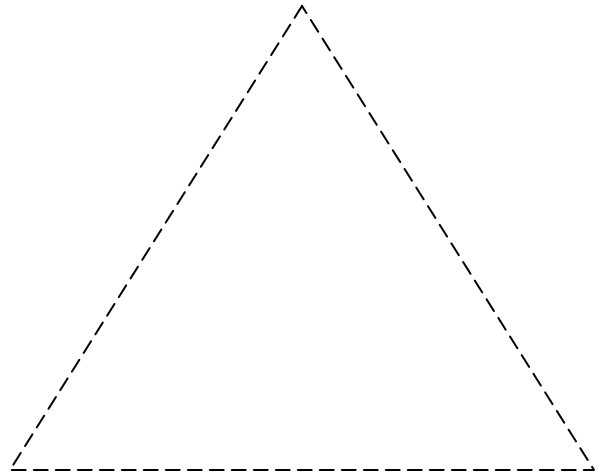
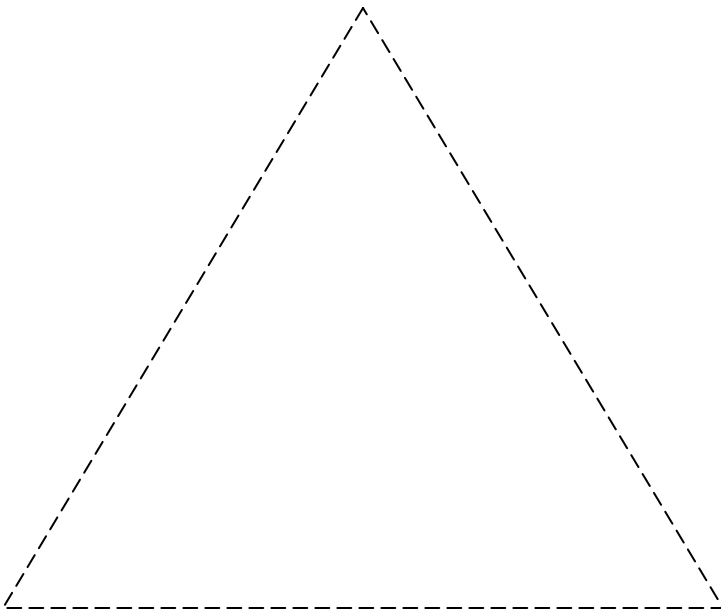
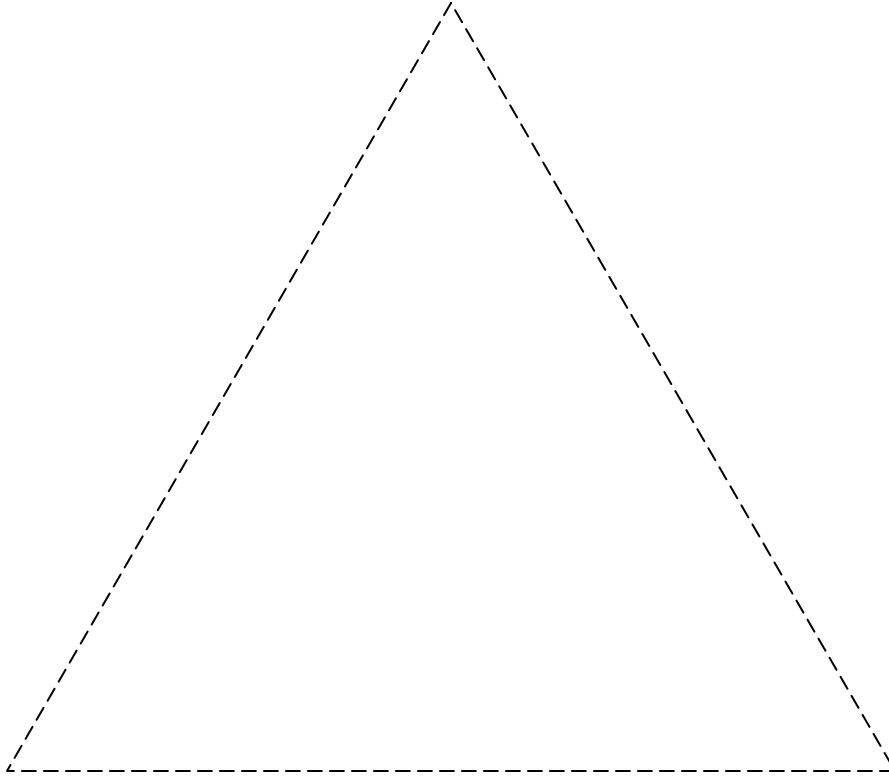

triangle

Name: _____

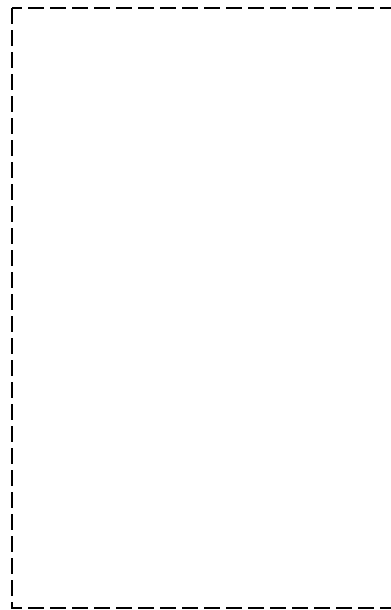
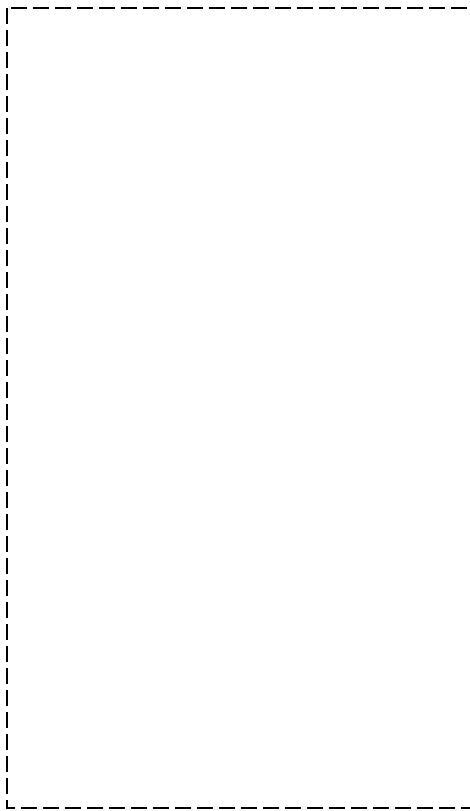

rectangle

Name: _____

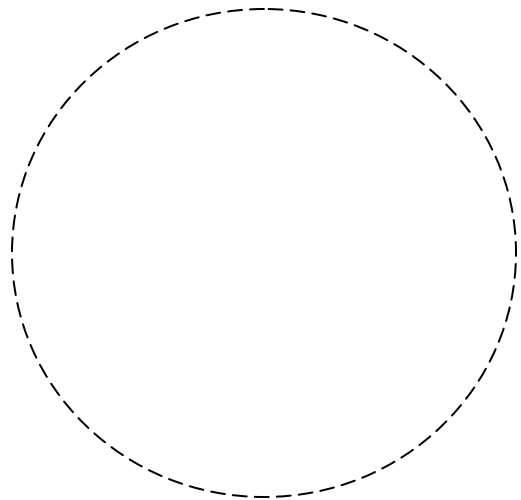
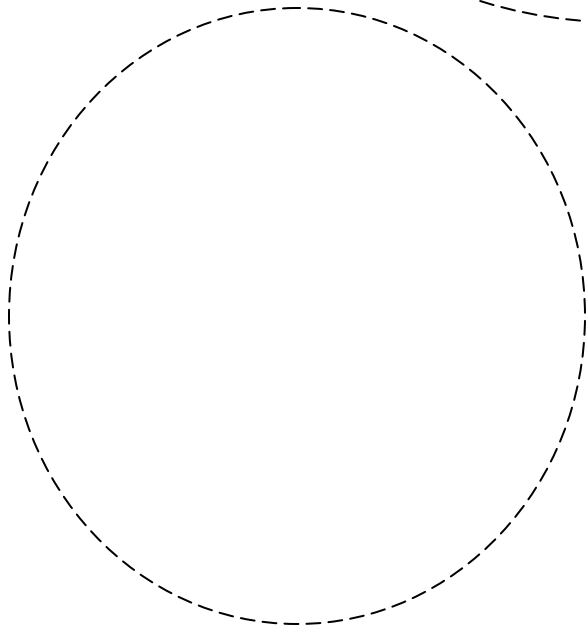
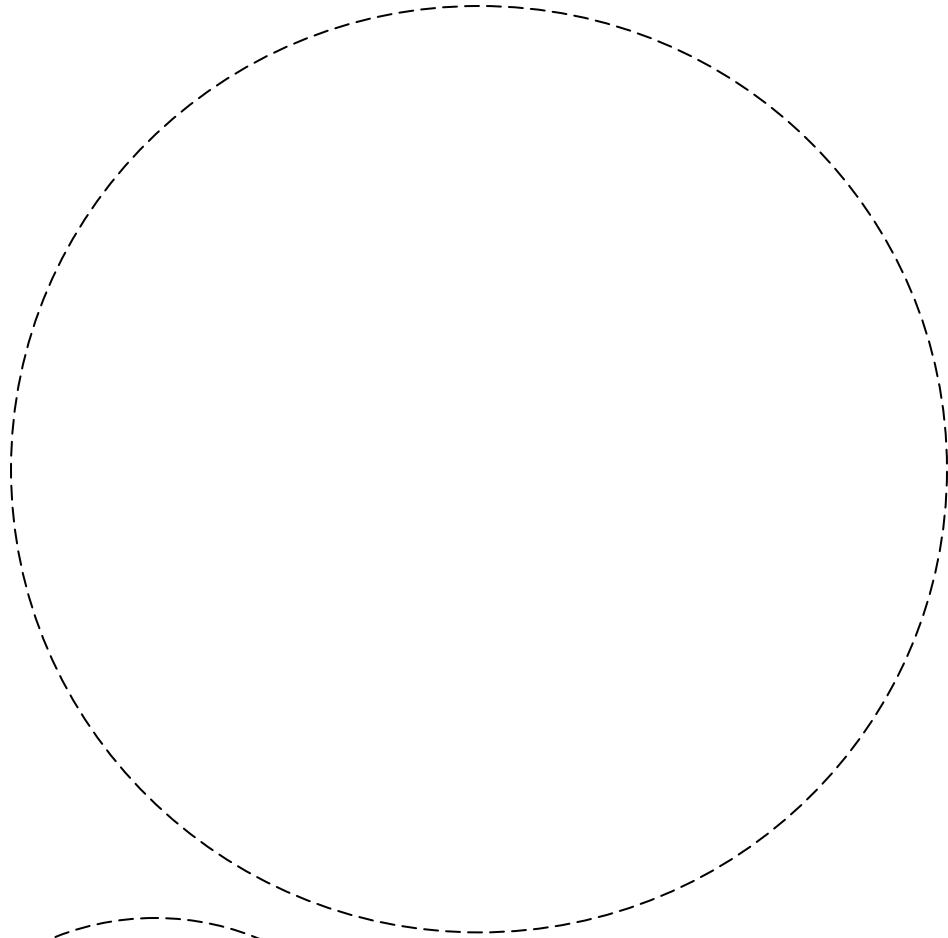

circle

Name: _____

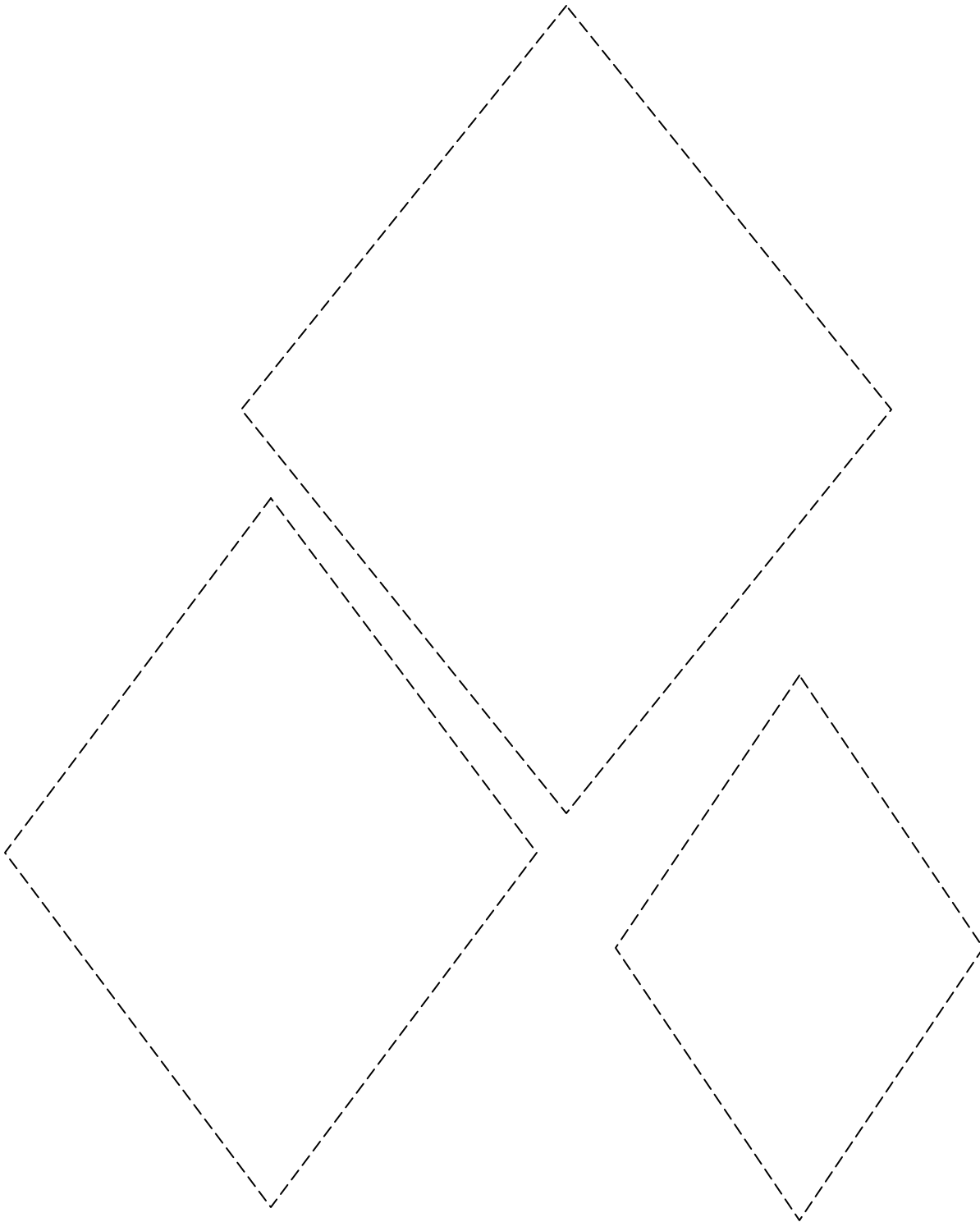

diamond

Name: _____

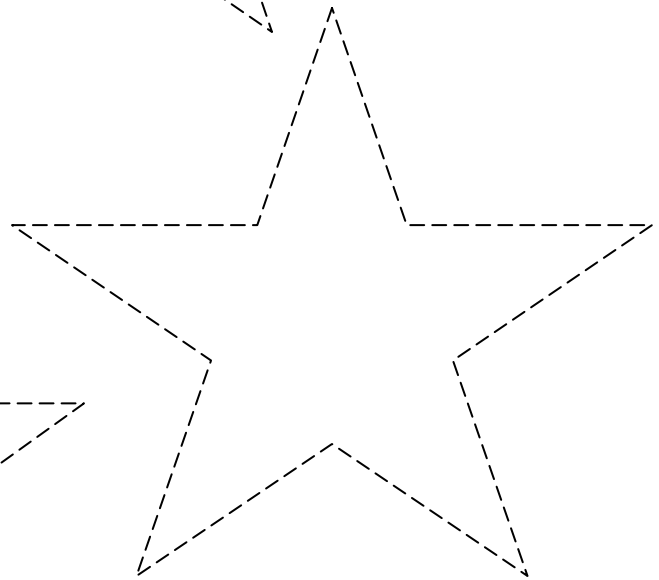
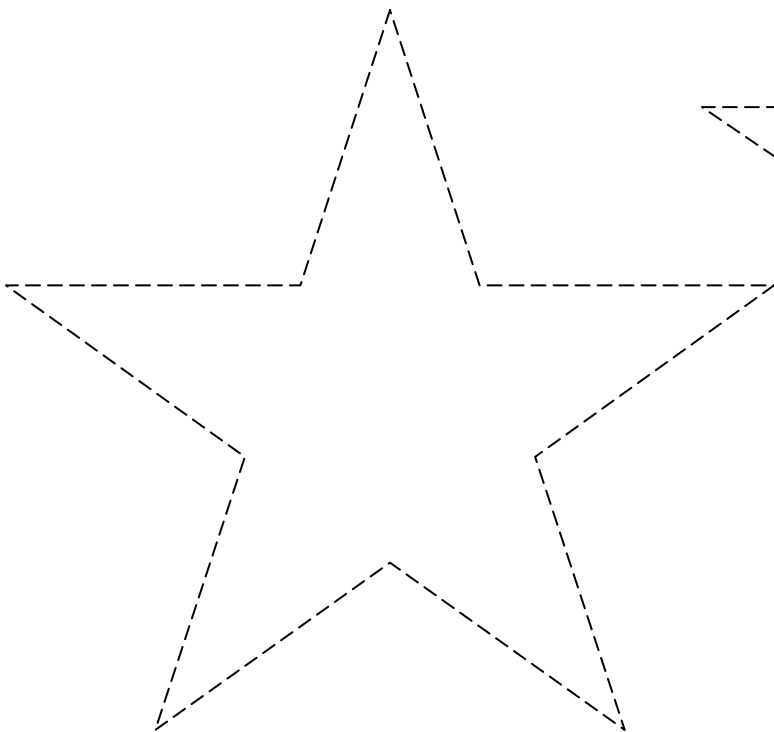
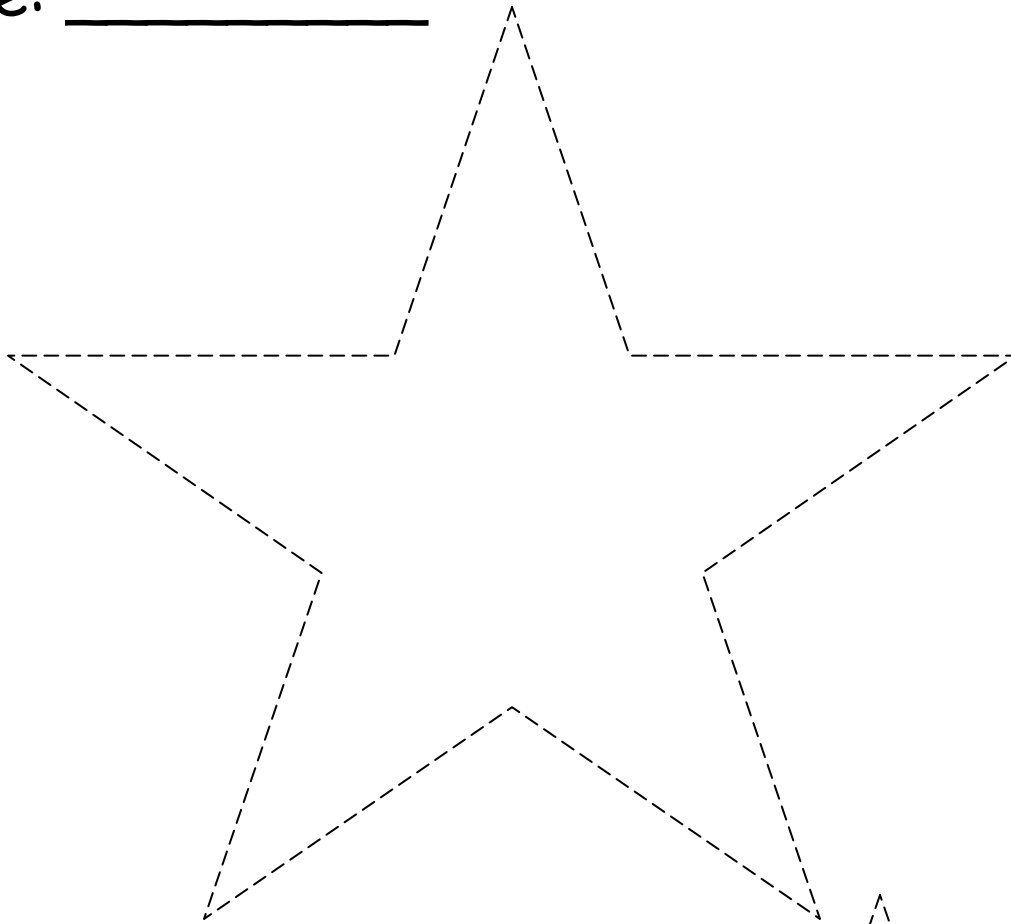

star

Name: _____

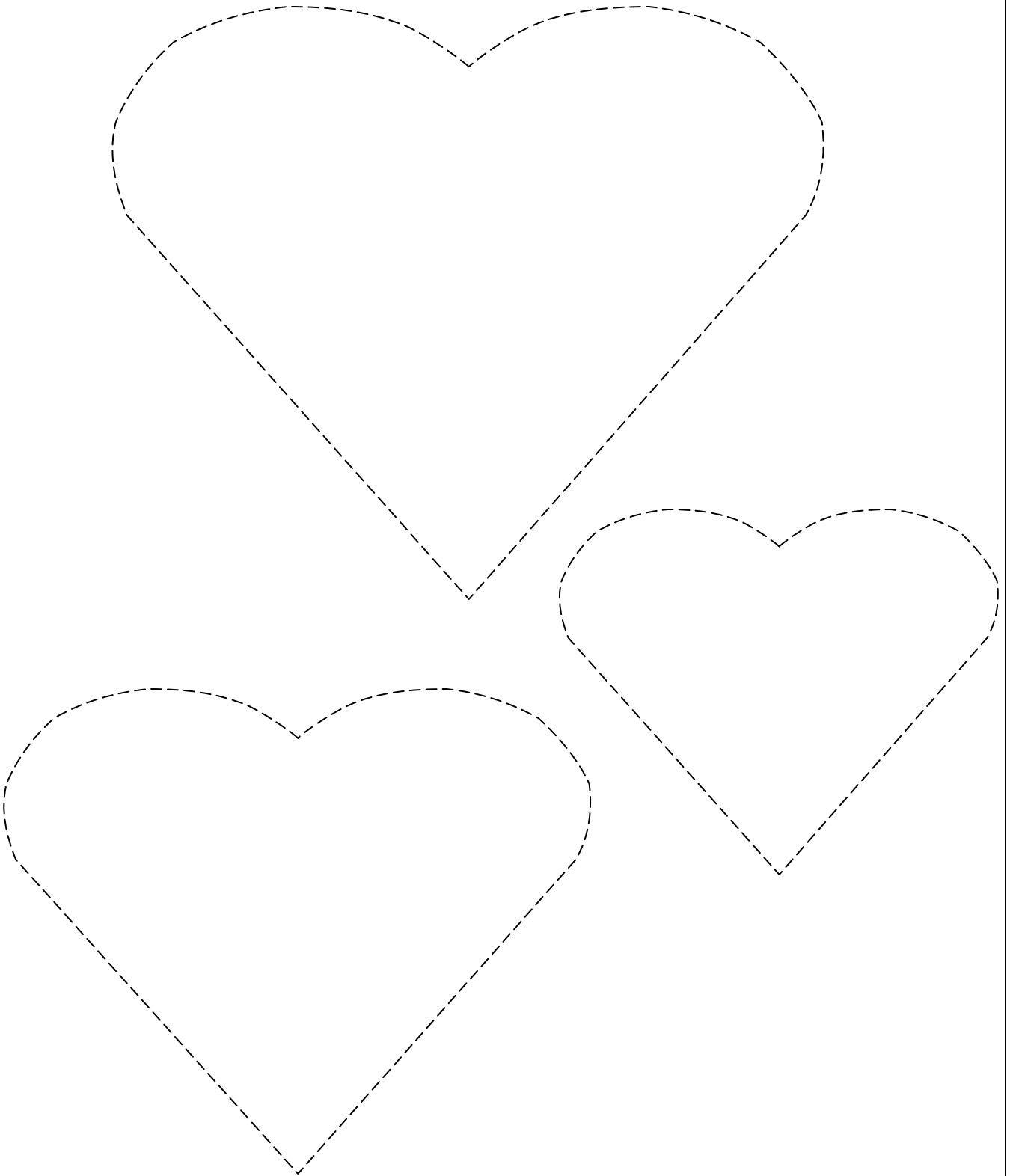

heart

Name: _____

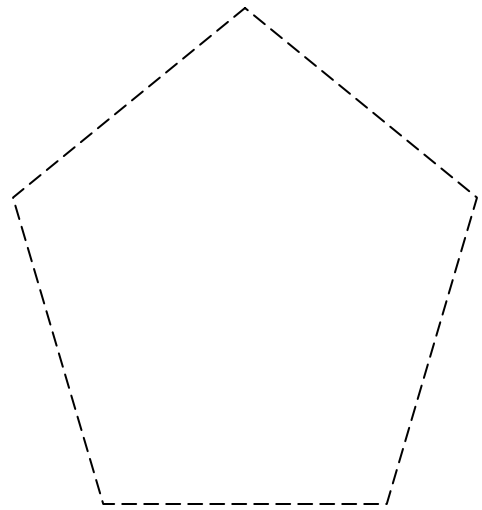
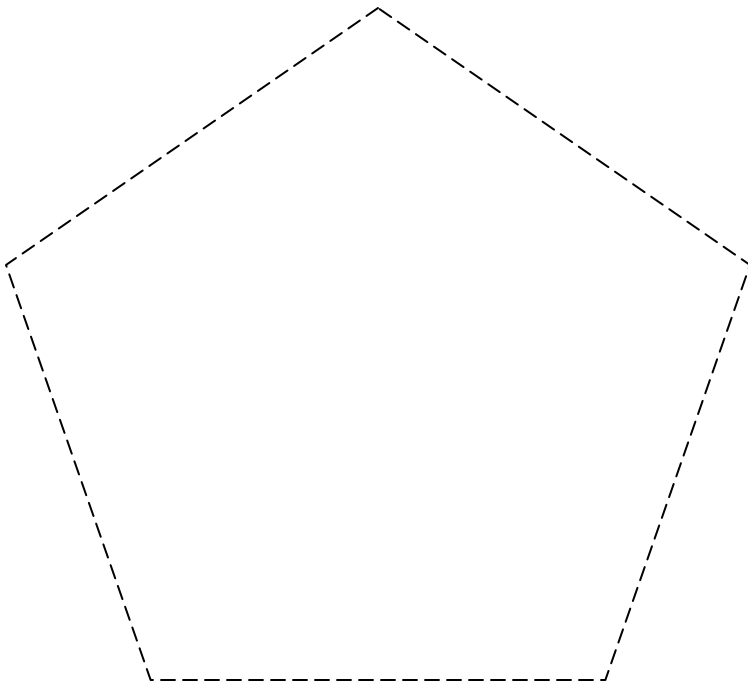
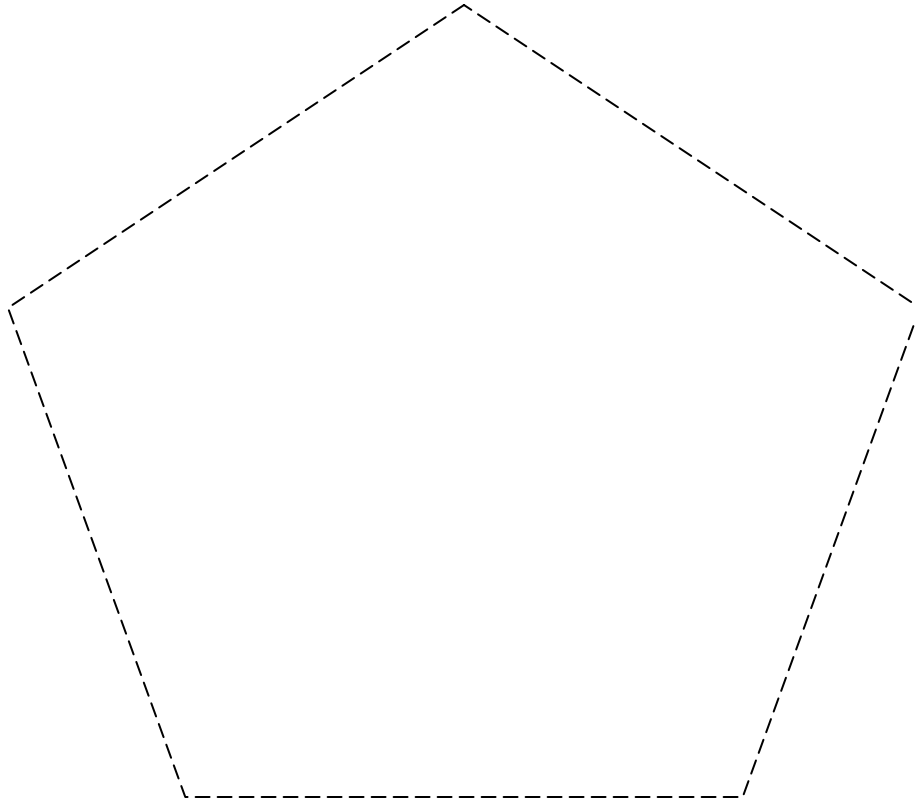

pentagon

Name: _____

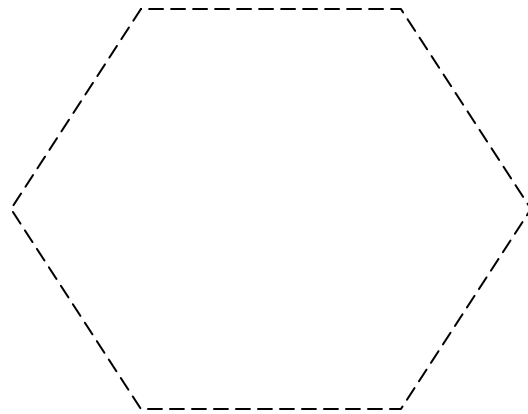
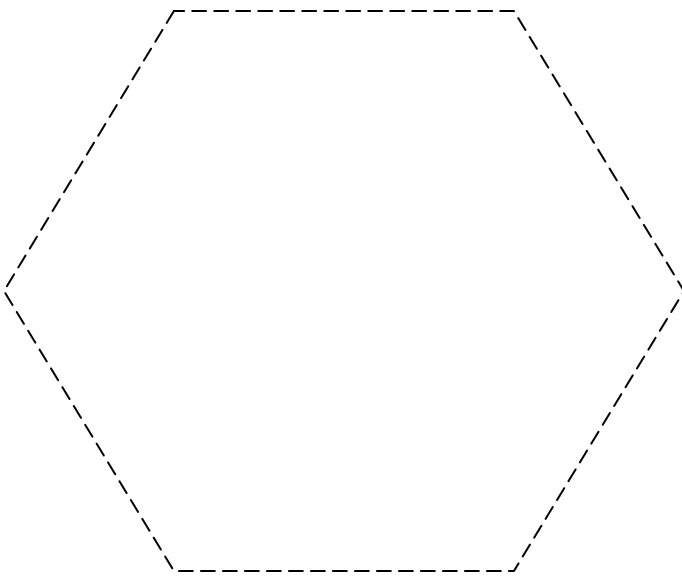
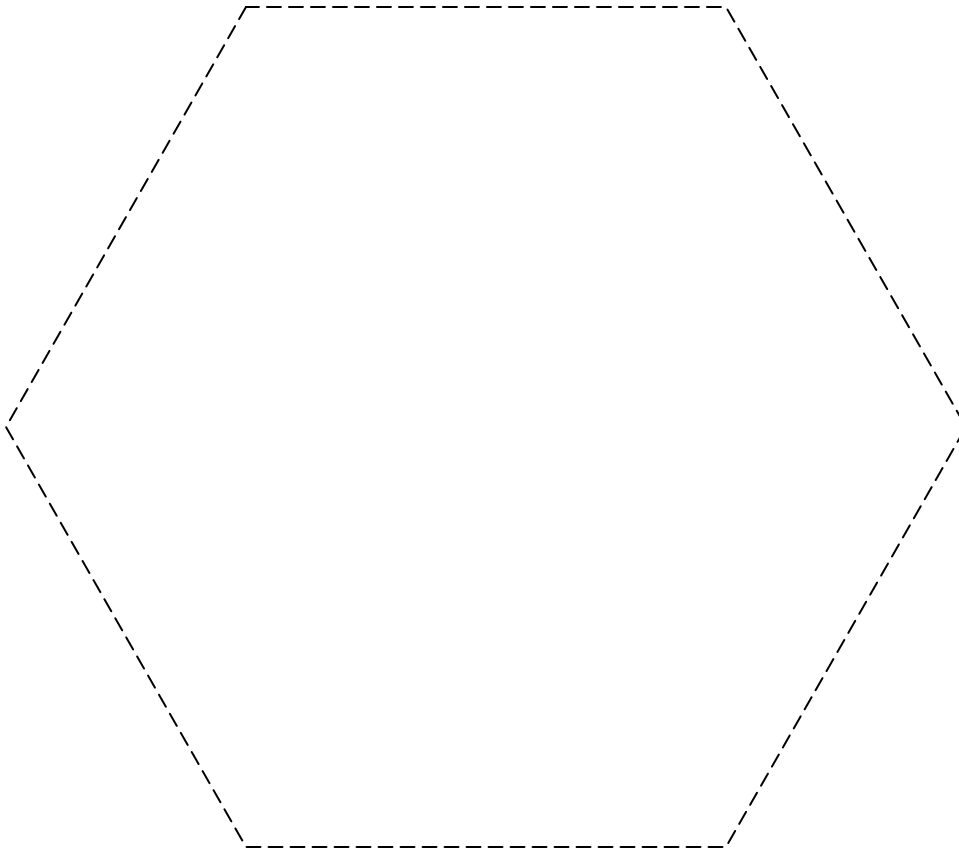

hexagon

Name: _____

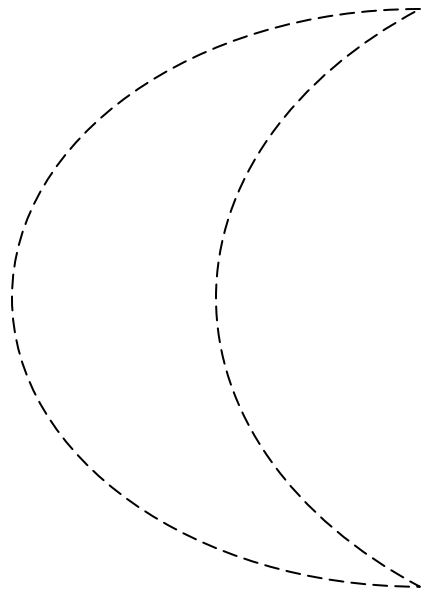
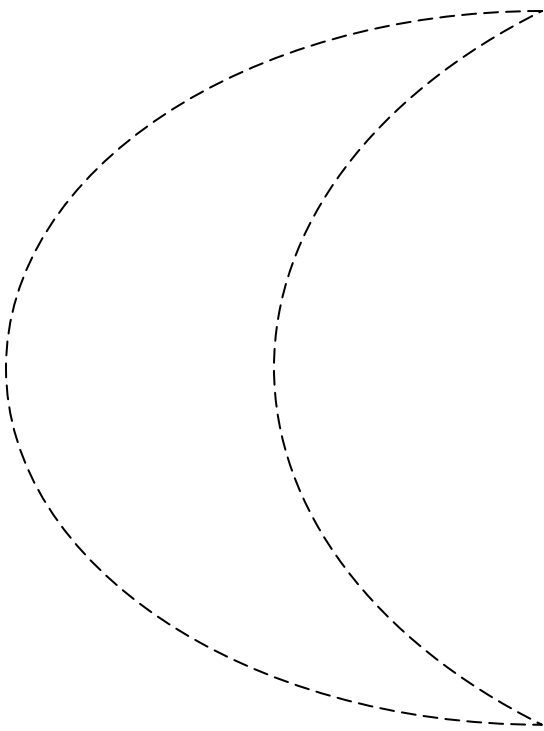
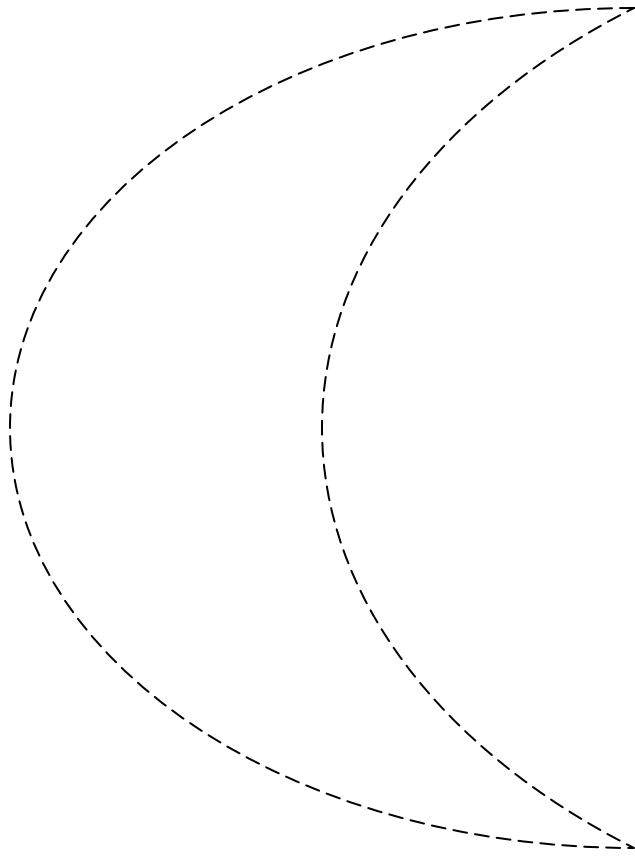

crescent

Name: _____

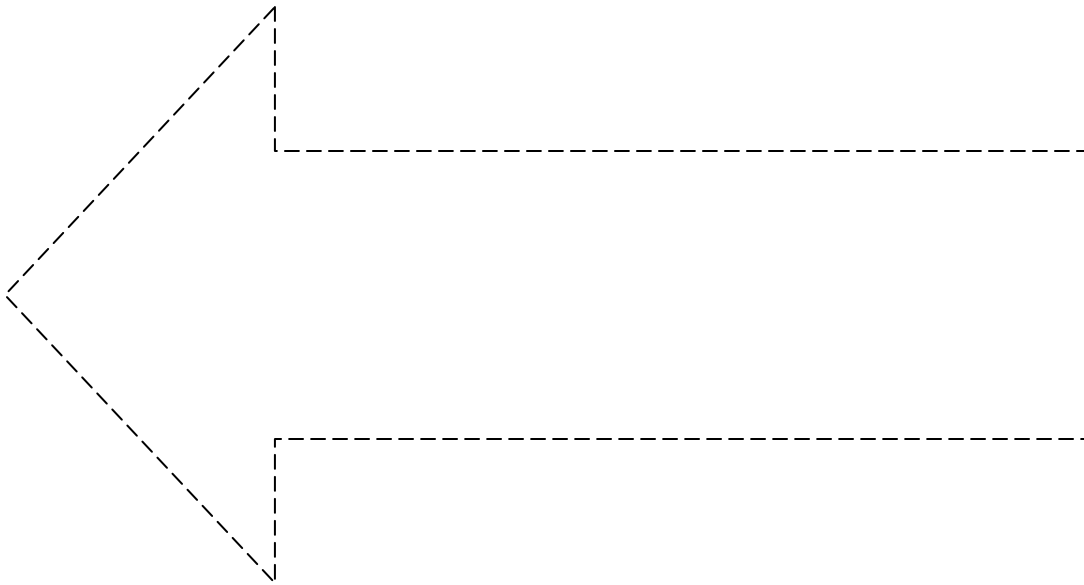
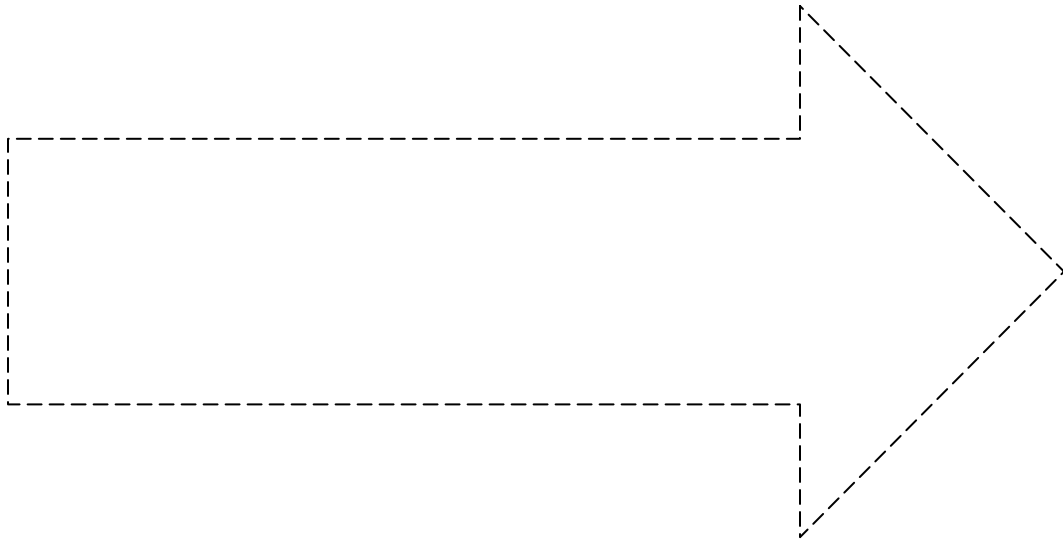

arrow

Name: _____

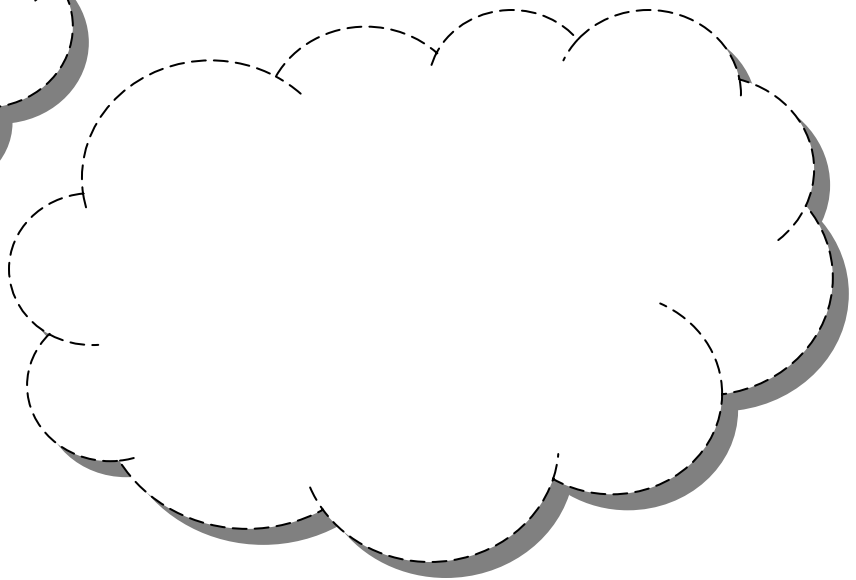
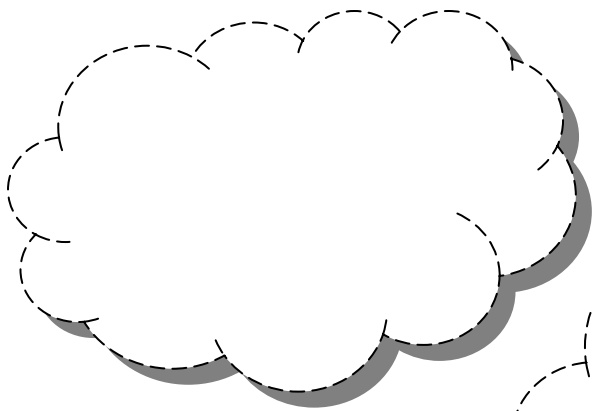
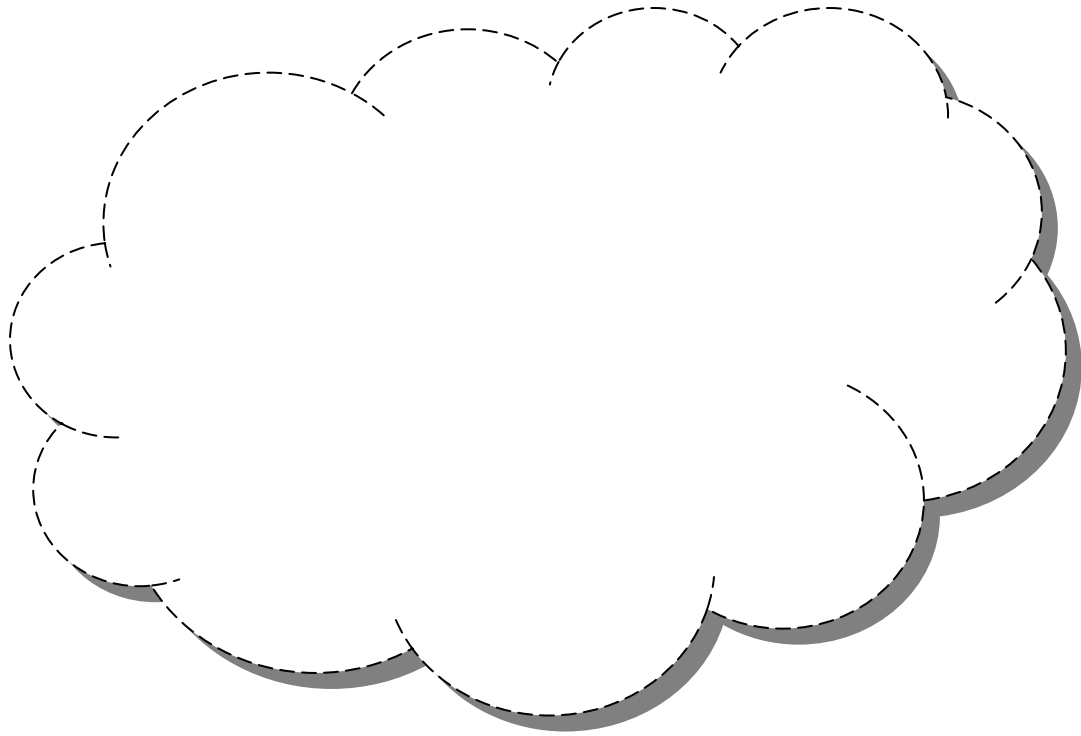

What does this look like? Trace the shapes and finish the picture.

Name: _____

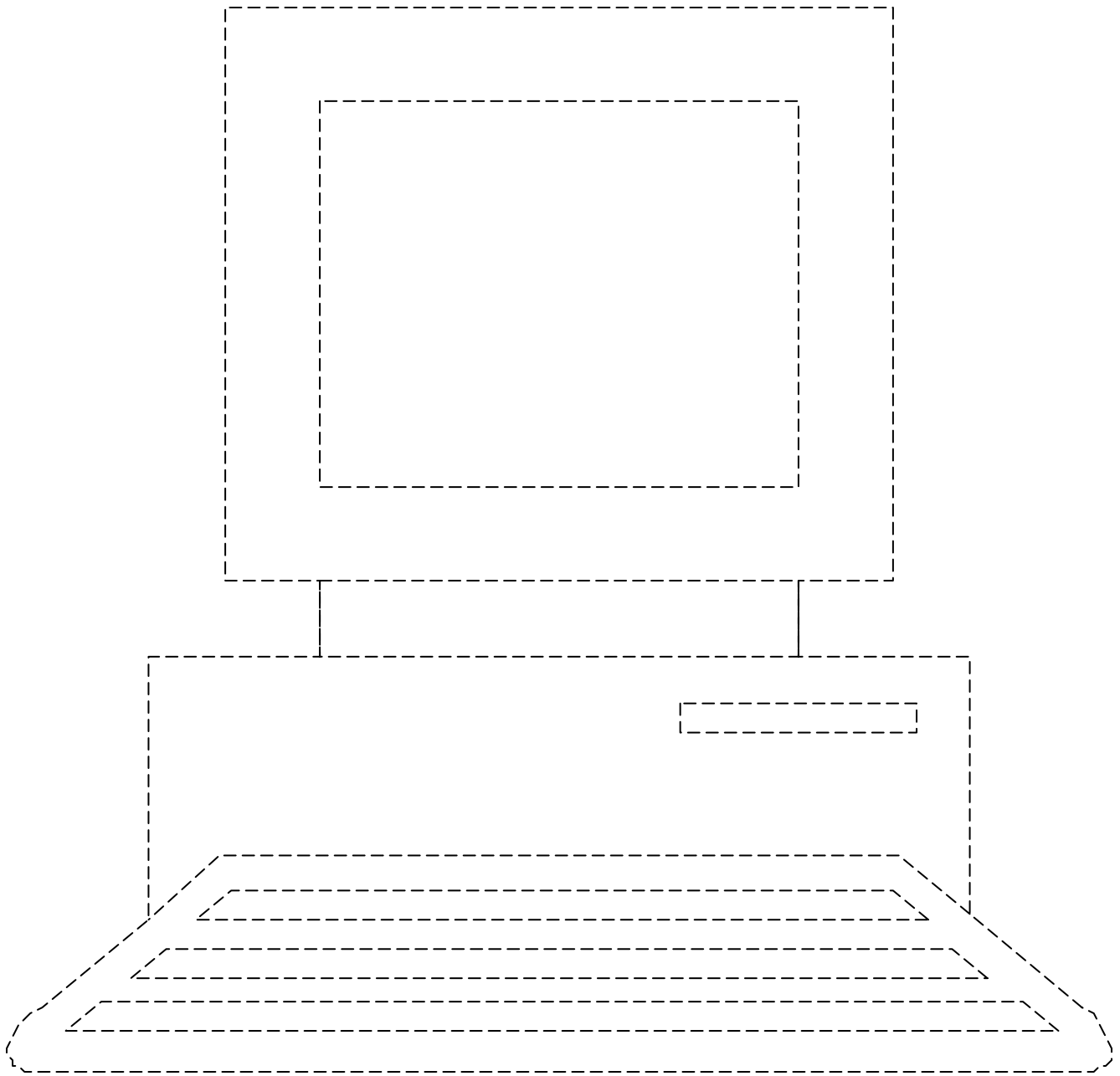

What does this look like? Trace the shapes and finish the picture.

Name: _____

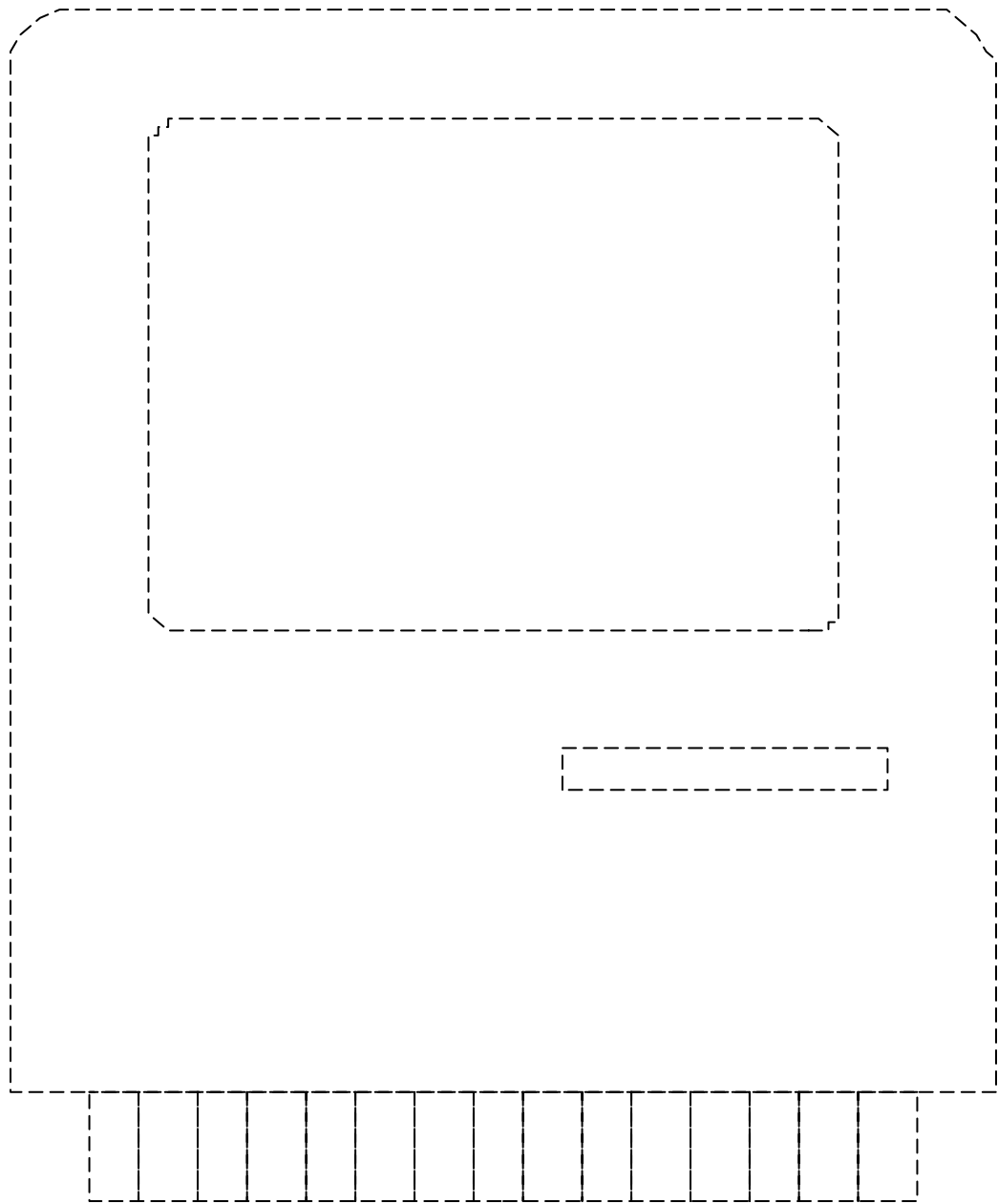

What does this look like? Trace the shapes and finish the picture.

Name: _____

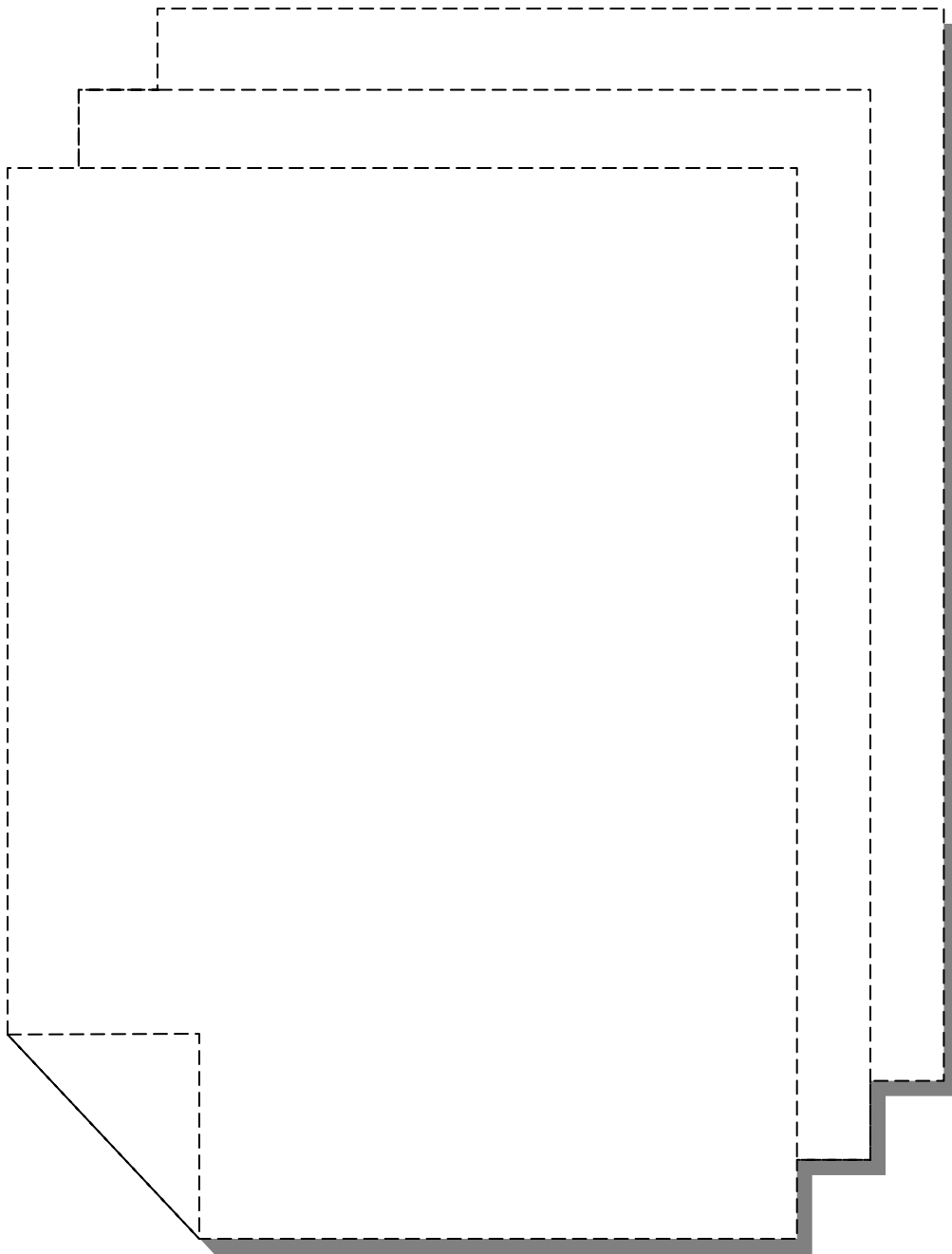

What does this look like? Trace the shapes and finish the picture.

Name: _____

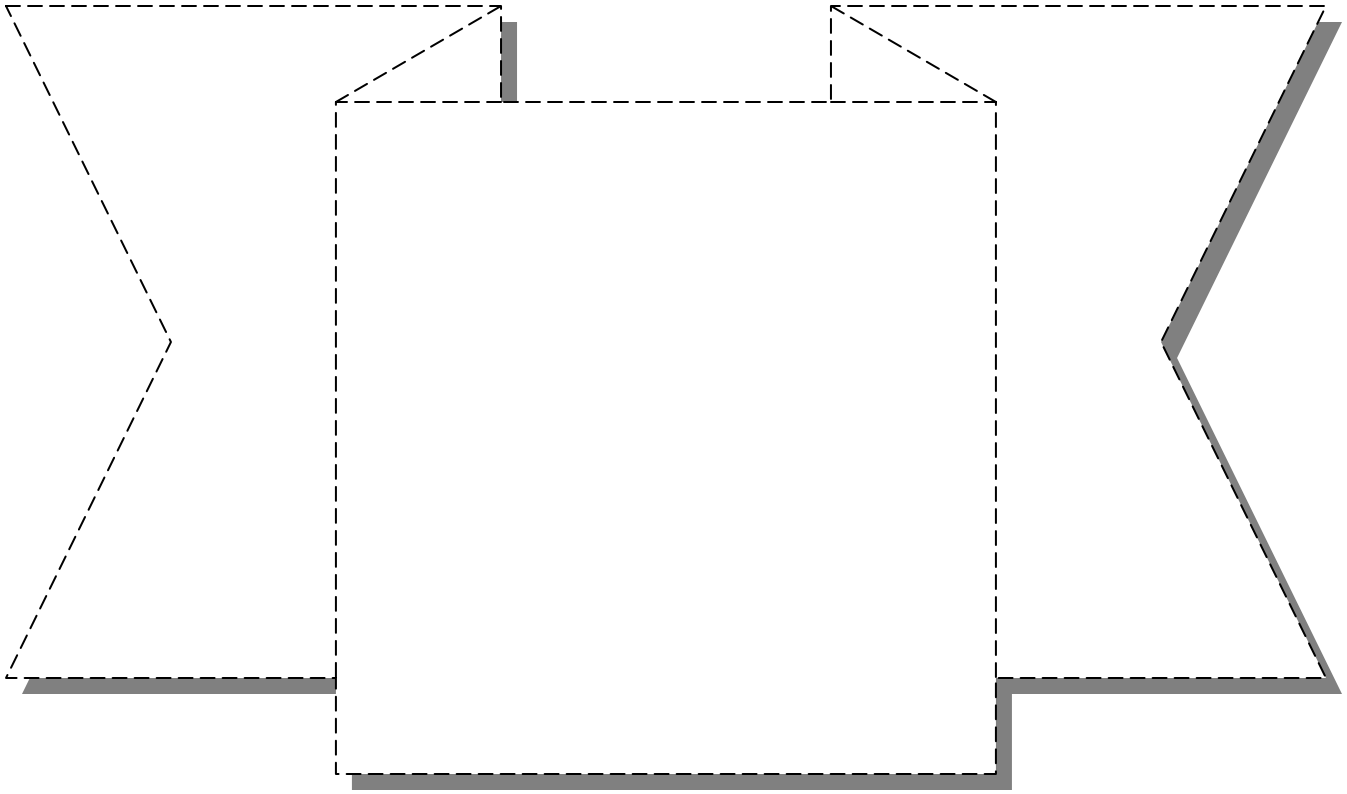

What does this look like? Trace the shapes and finish the picture.

Name: _____

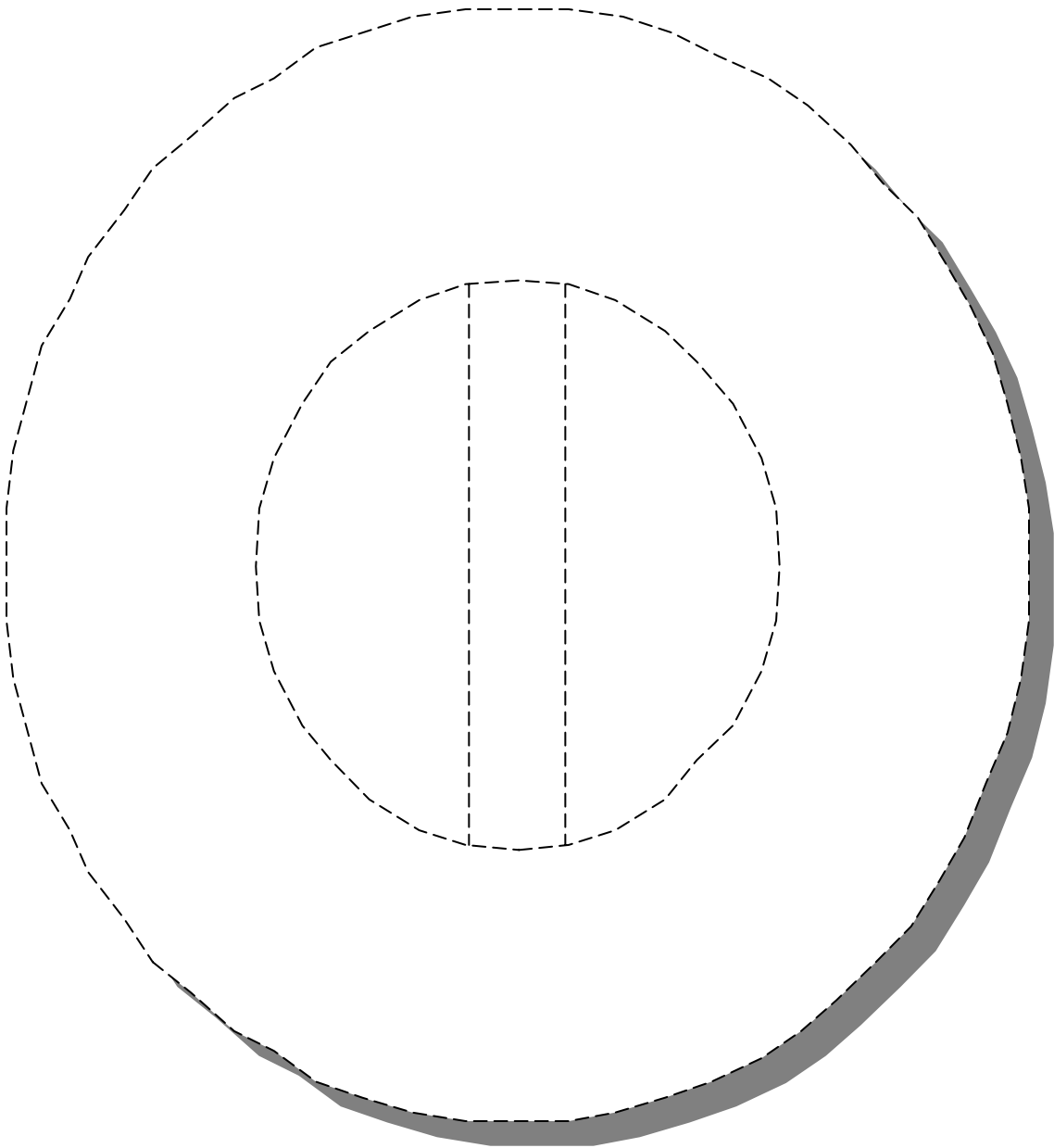

What does this look like? Trace the shapes and finish the picture.

Name: _____

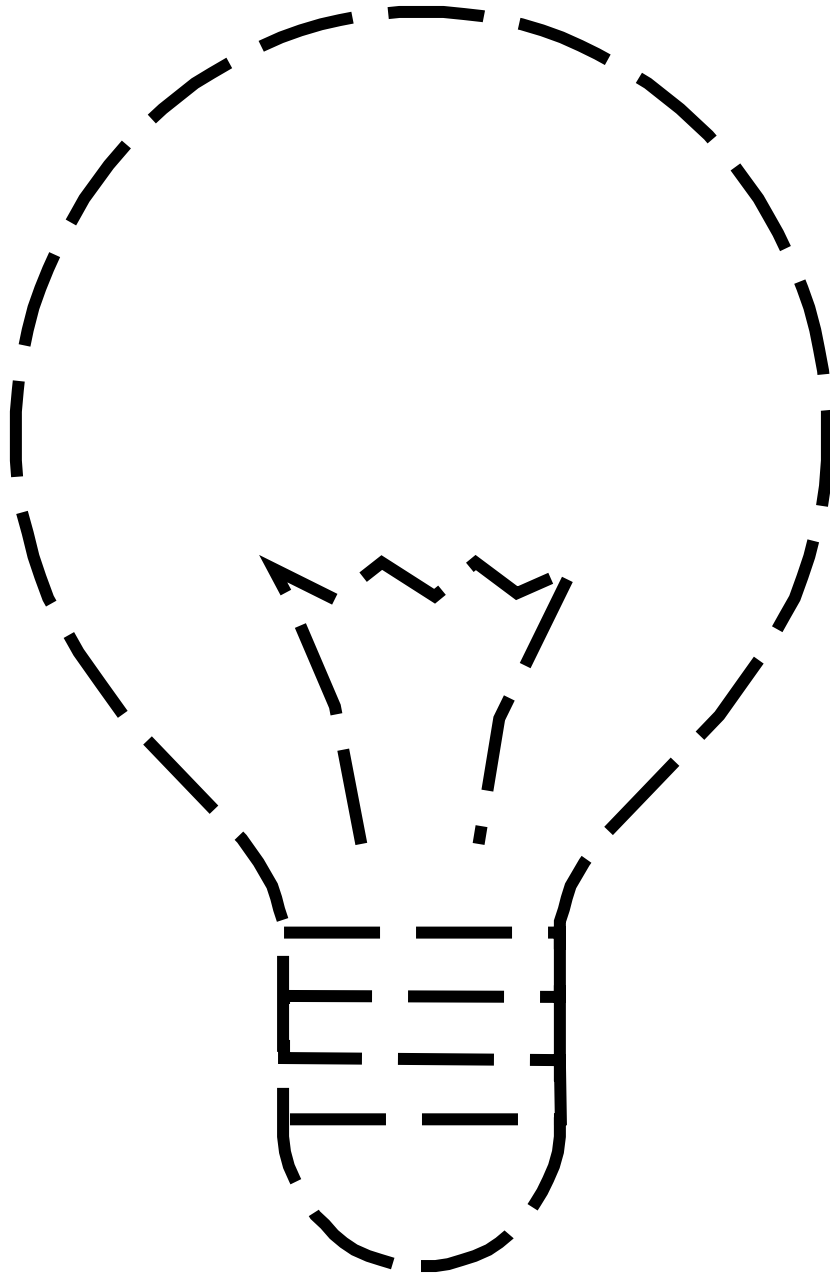

What does this look like? Trace the shapes and finish the picture.

Name: _____

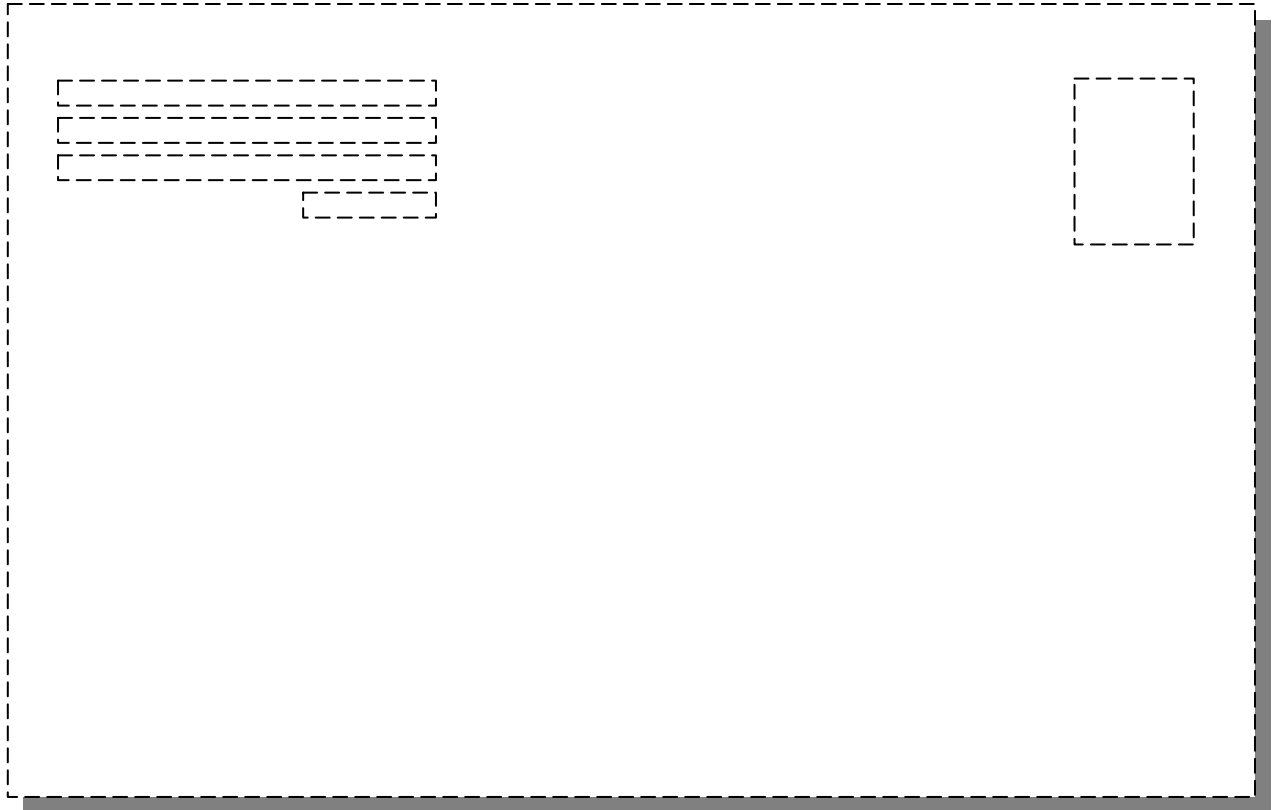

What does this look like? Trace the shapes and finish the picture.

Name: _____

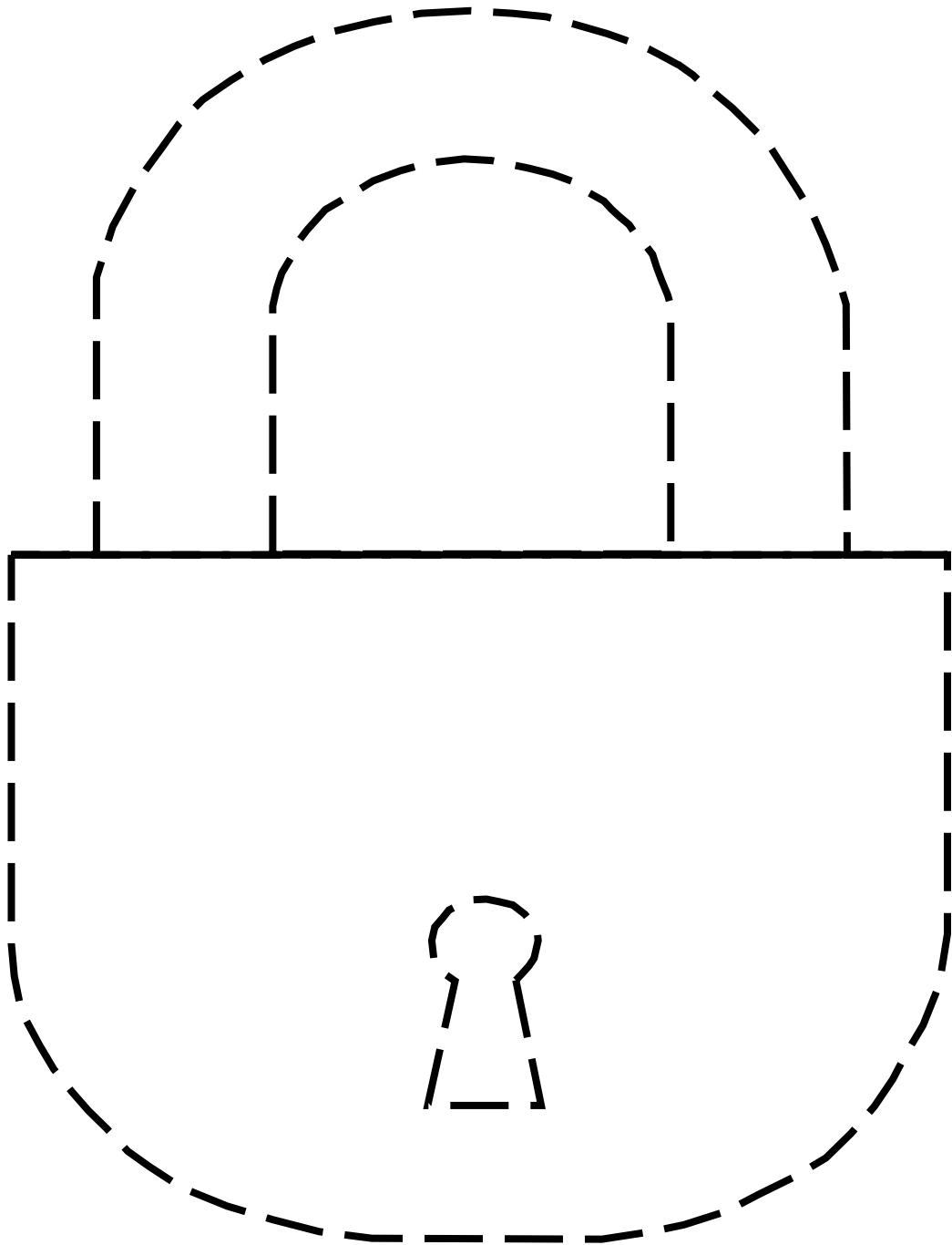

What does this look like? Trace the shapes and finish the picture.

Name: _____

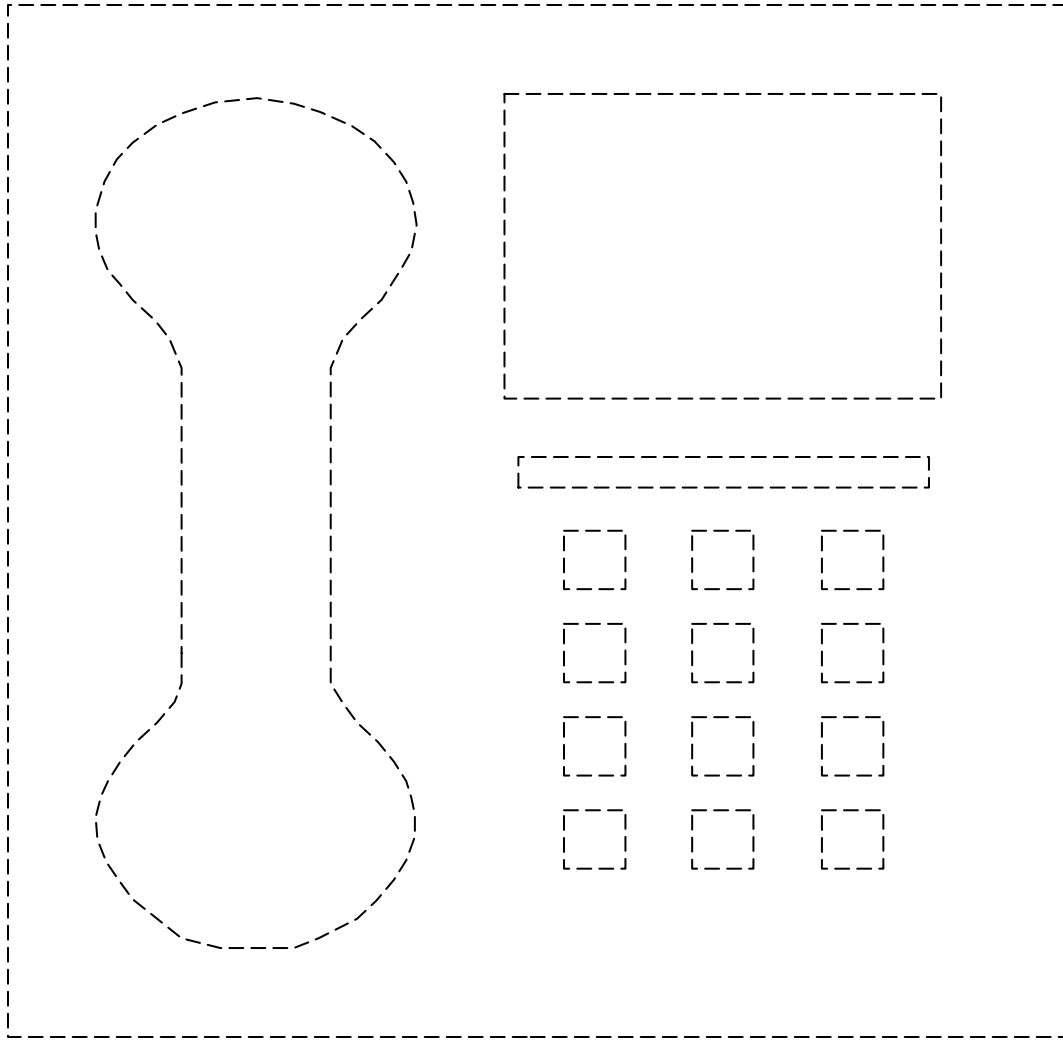

What does this look like? Trace the shapes and finish the picture.

Name: _____

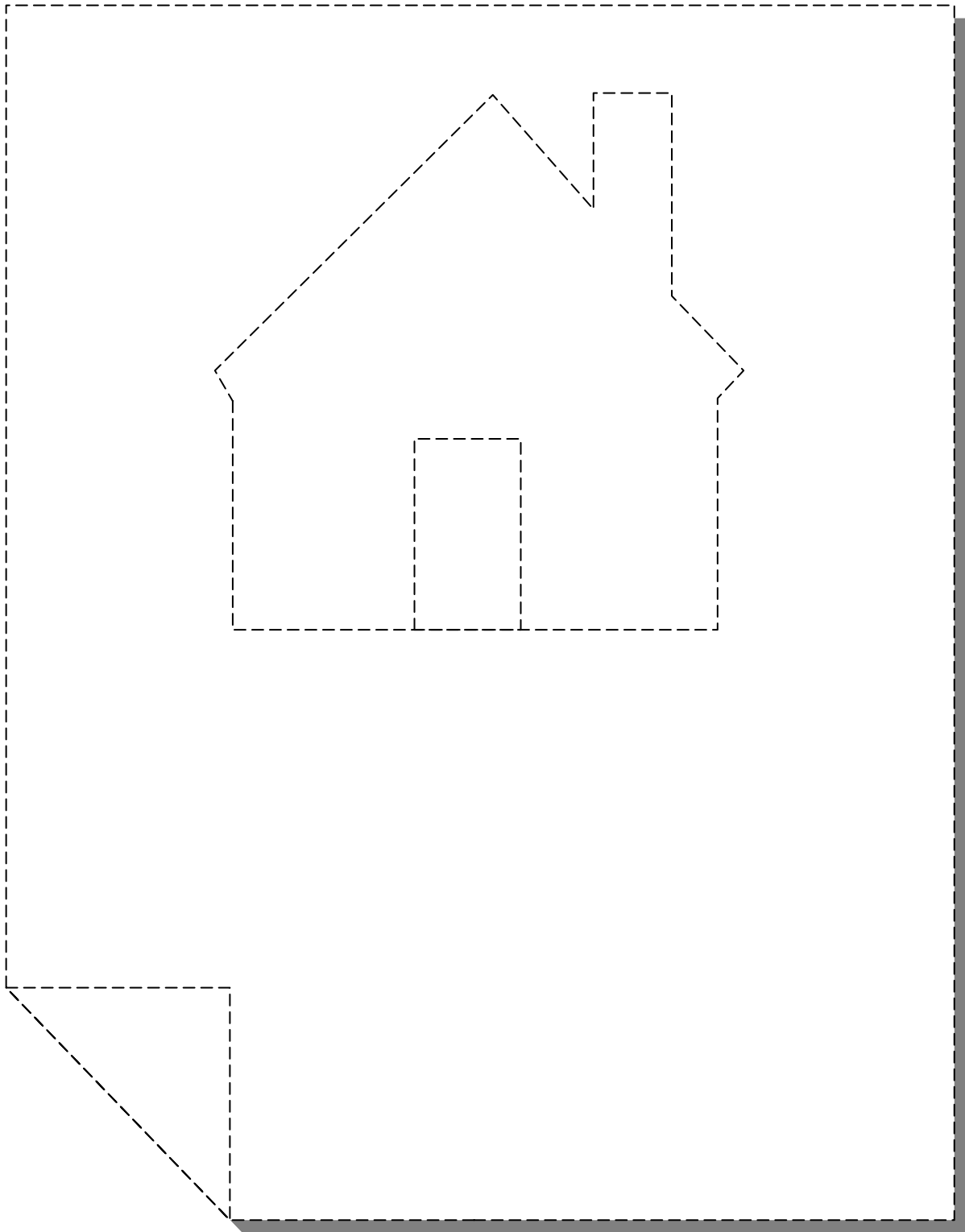

What does this look like? Trace the shapes and finish the picture.

Name: _____

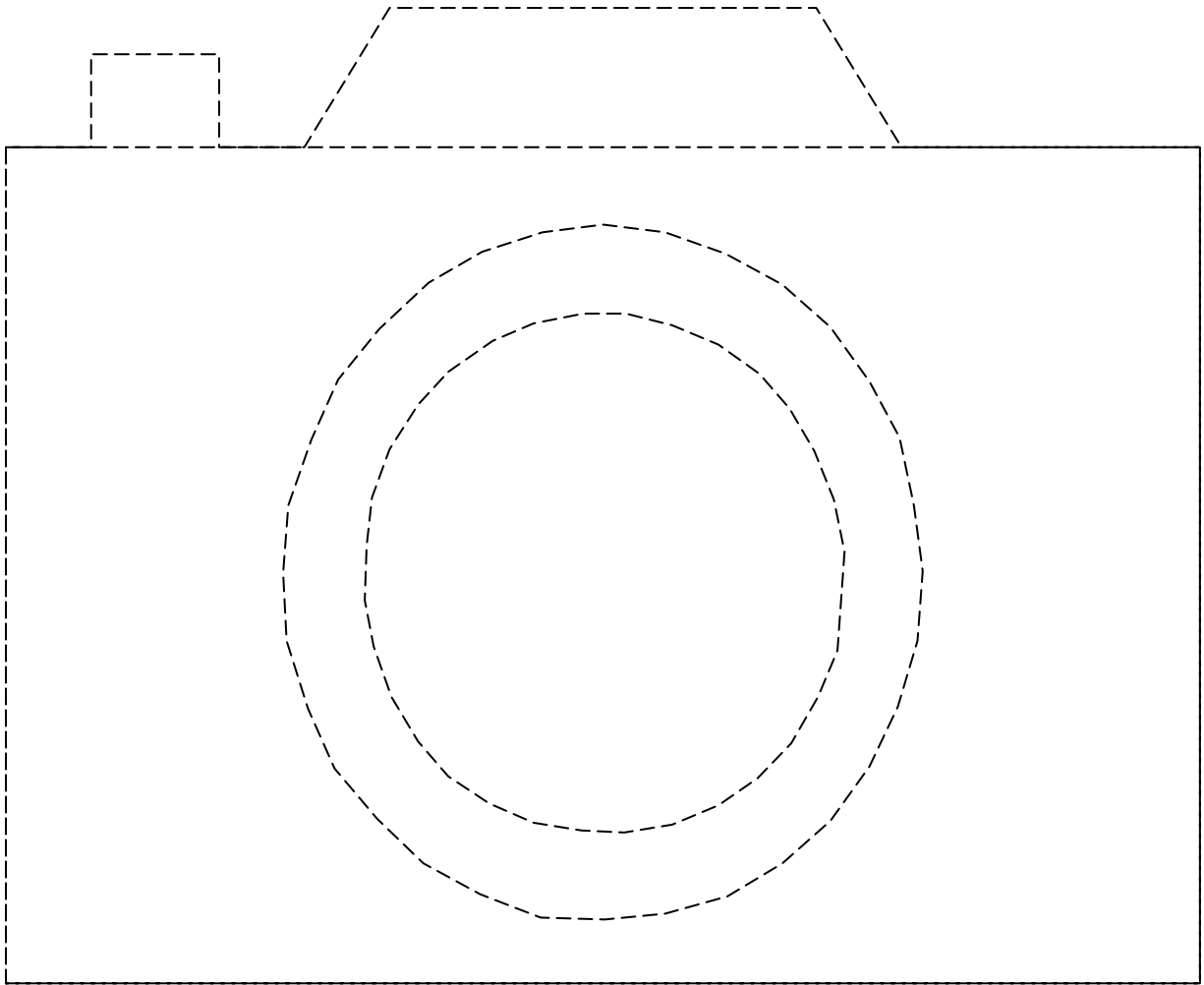

What does this look like? Trace the shapes and finish the picture.

Name: _____

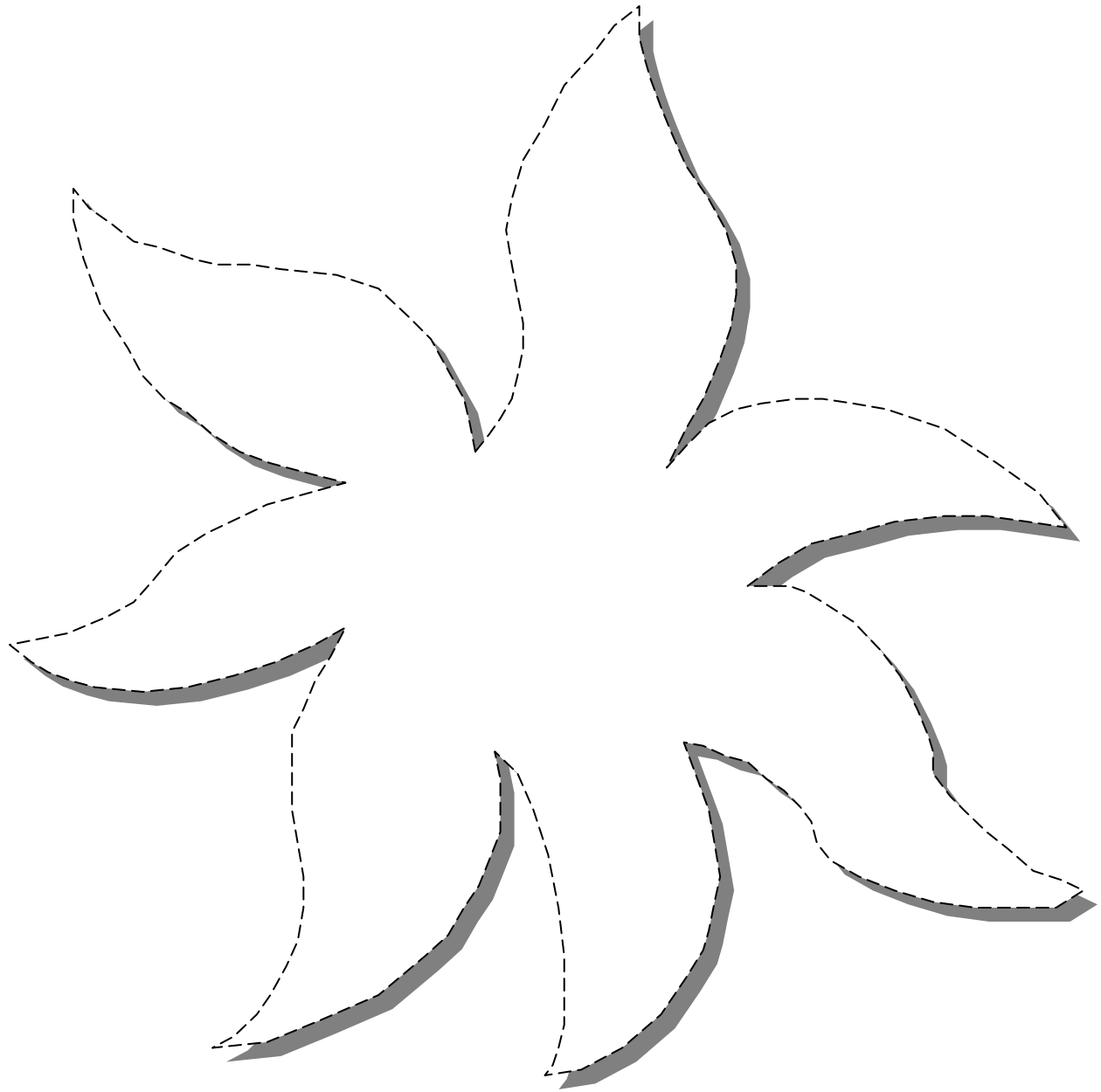

What does this look like? Trace the shapes and finish the picture.

Name: _____

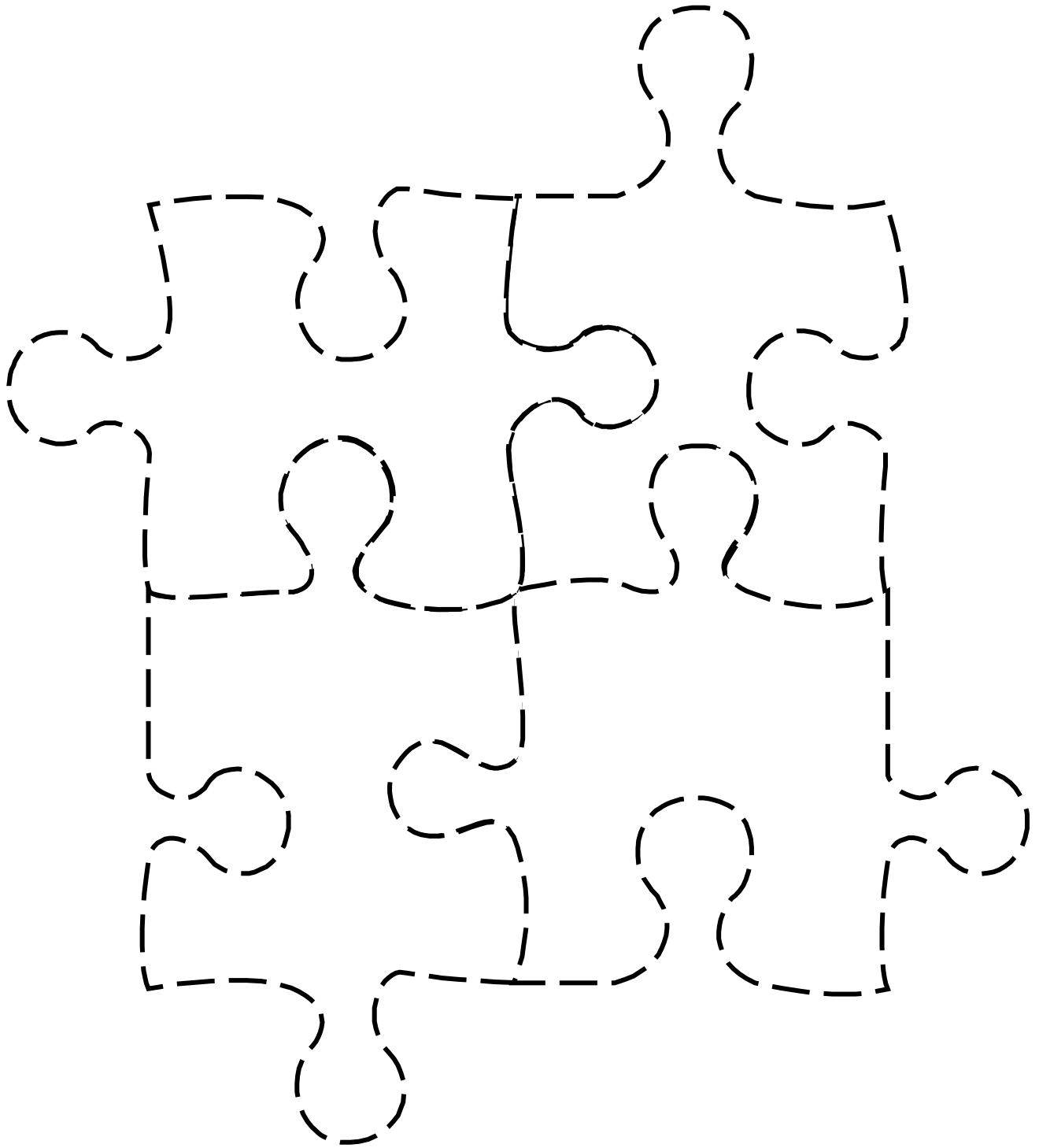

What does this look like? Trace the shapes and finish the picture.

Name: _____

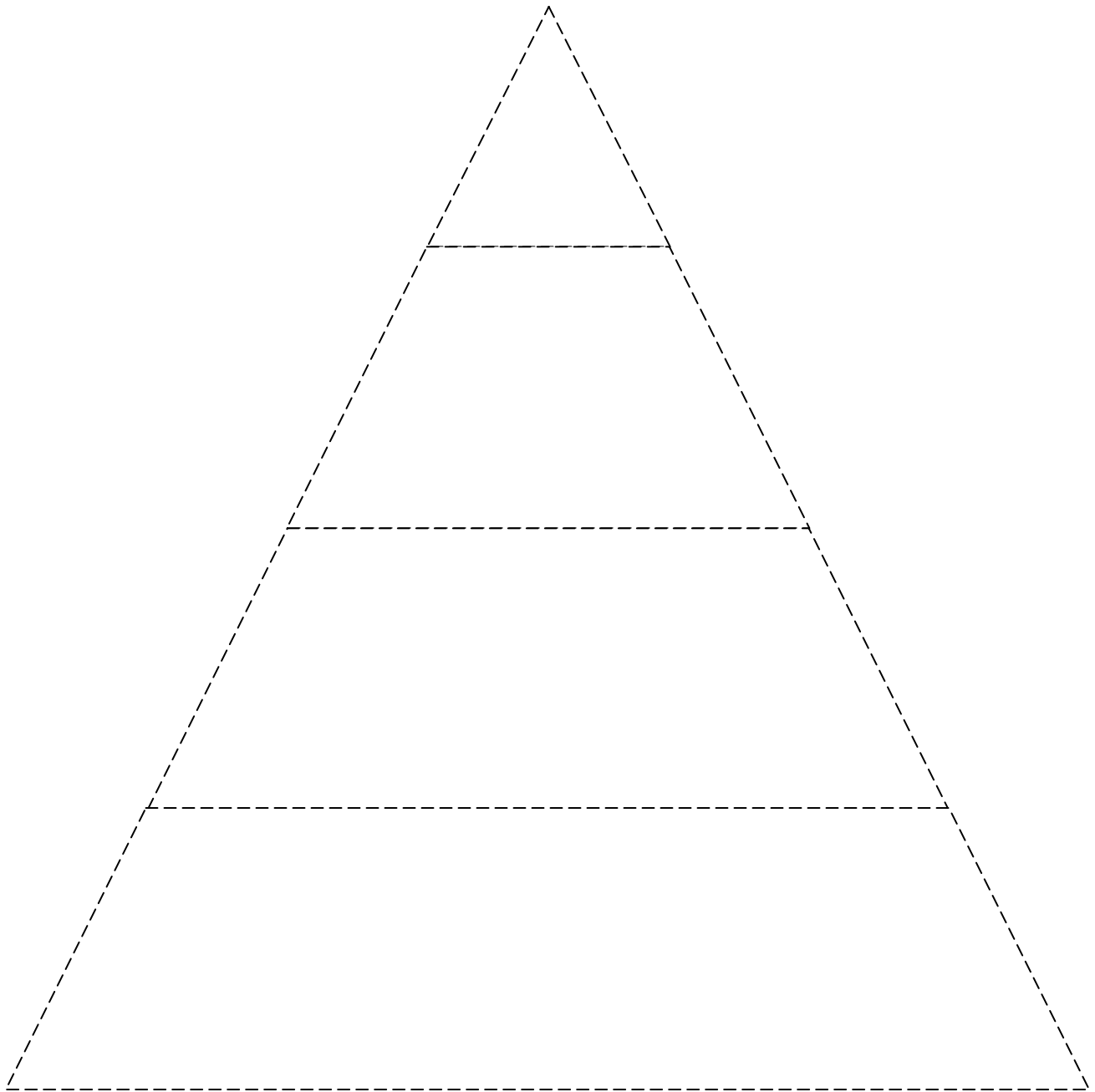

What does this look like? Trace the shapes and finish the picture.

Name: _____

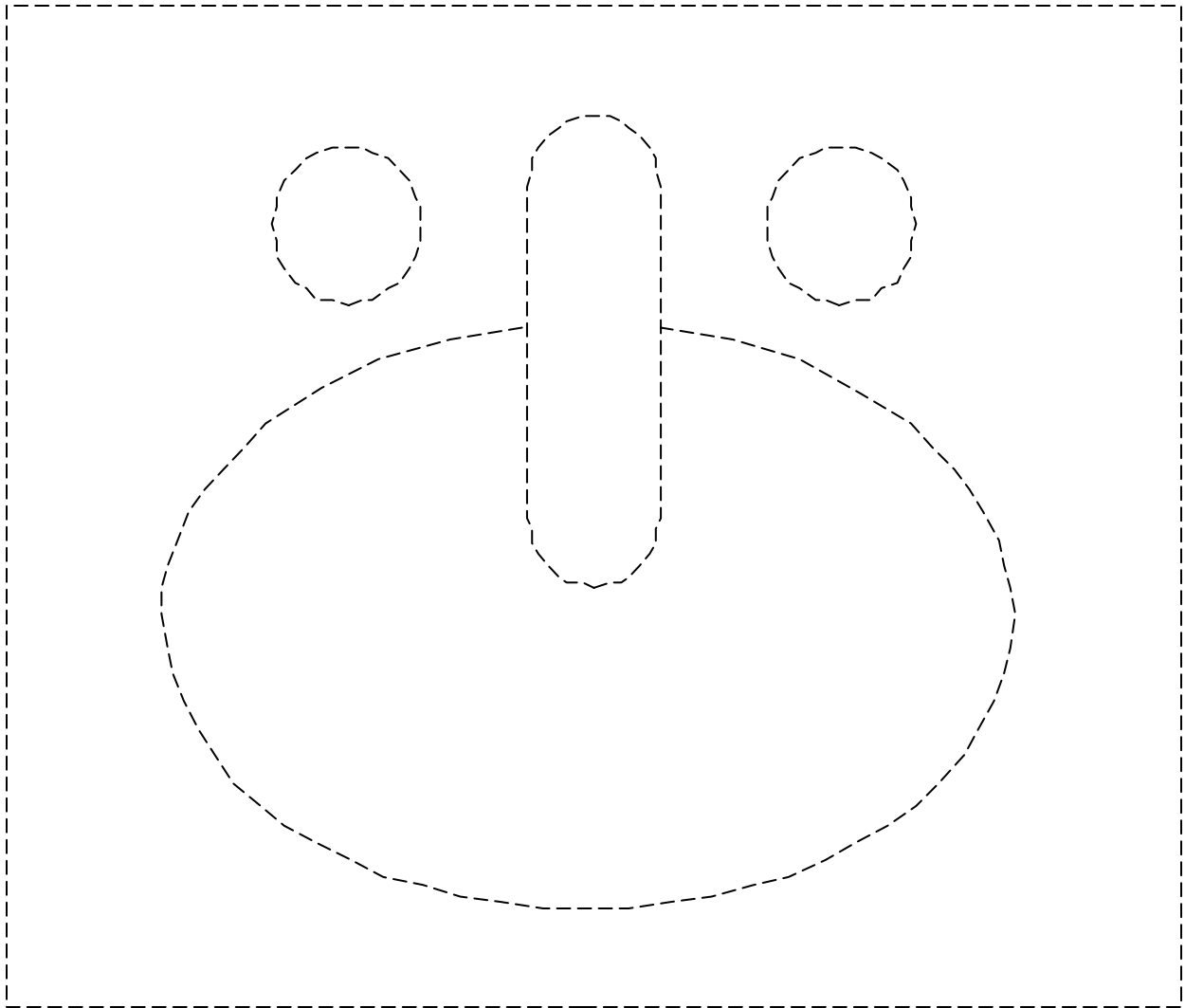

What does this look like? Trace the shapes and finish the picture.

Name: _____

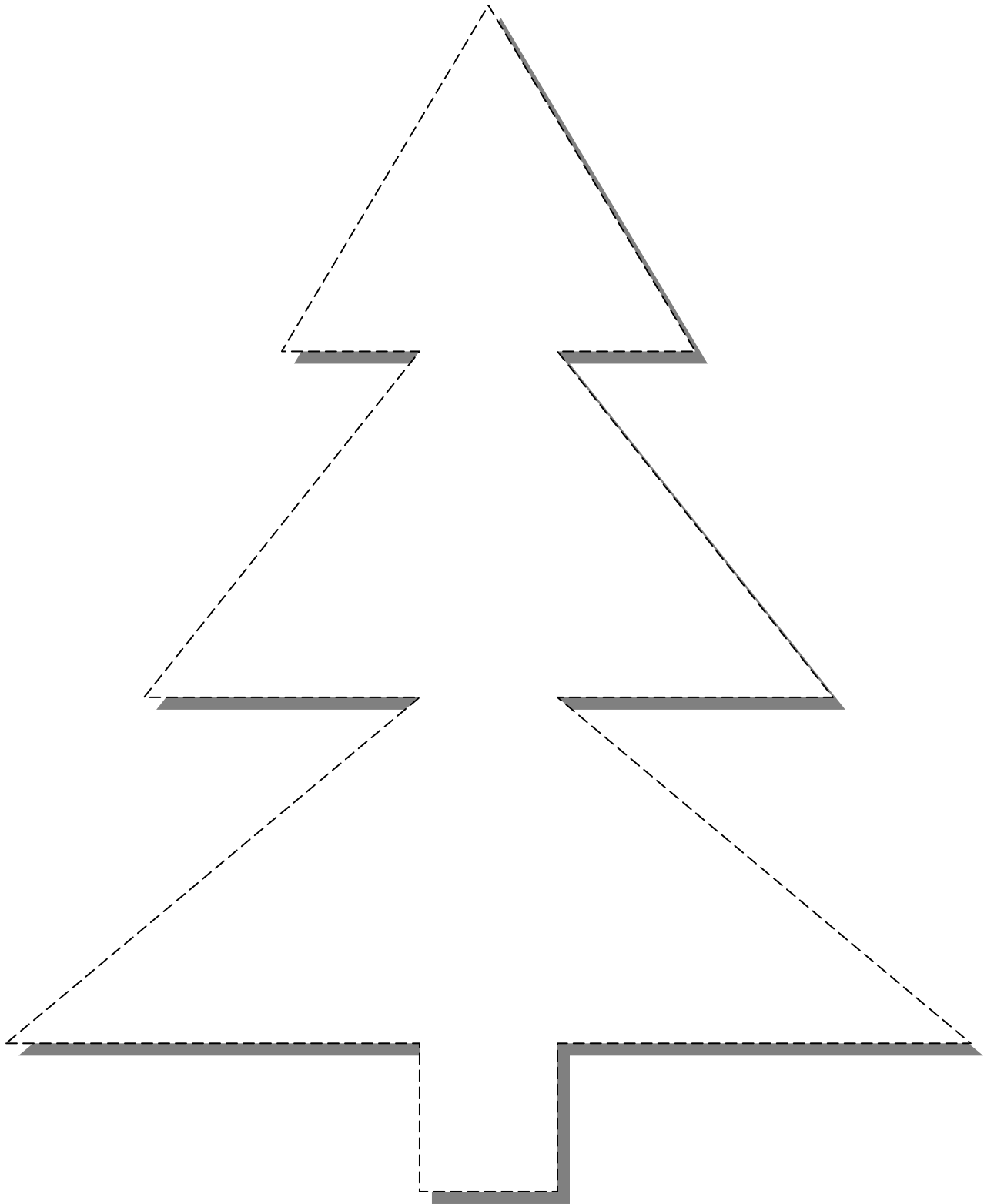

What does this look like? Trace the shapes and finish the picture.

Name: _____

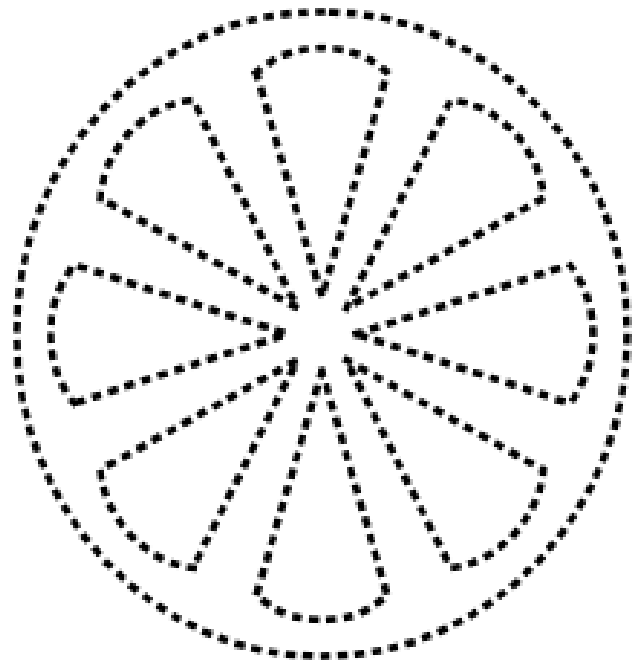
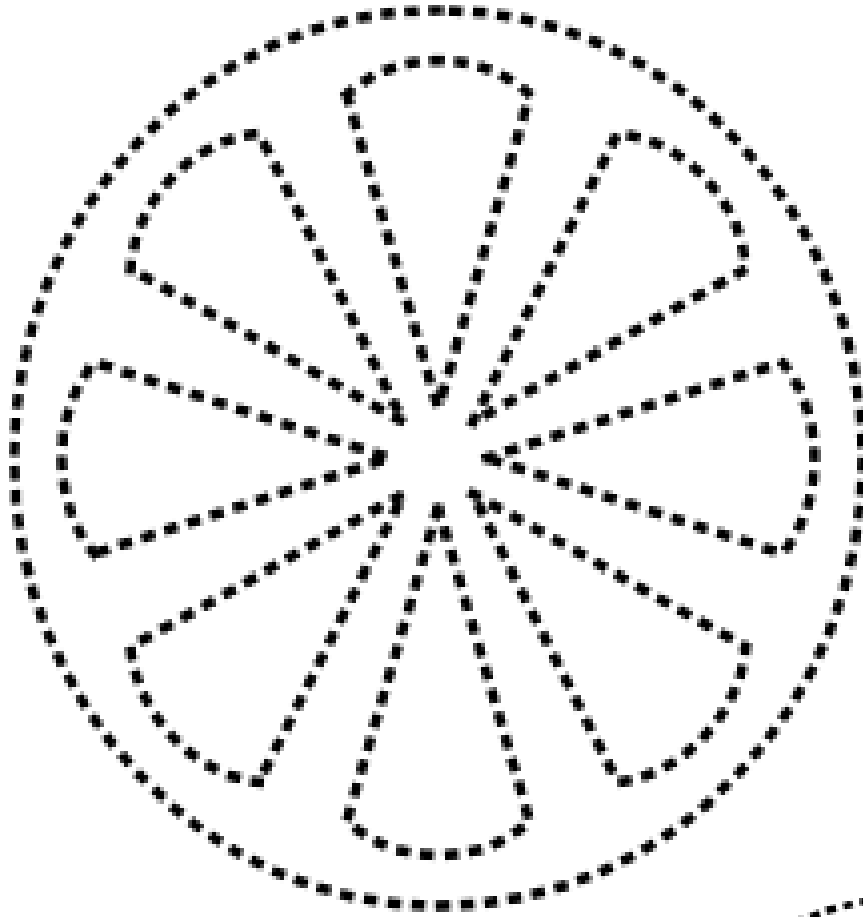

What does this look like? Trace the shapes and finish the picture.

Name: _____

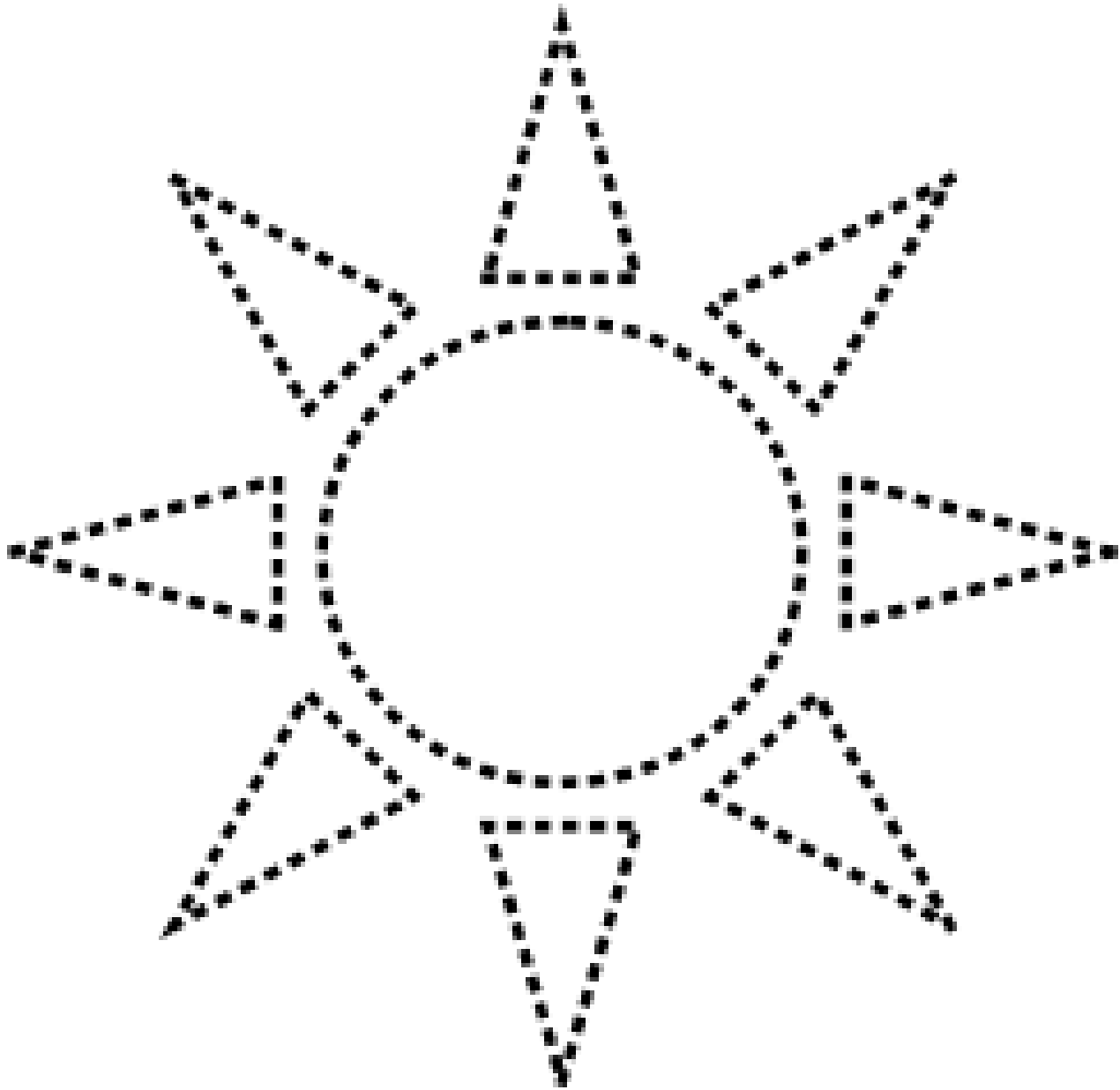

What does this look like? Trace the shapes and finish the picture.

Name: _____

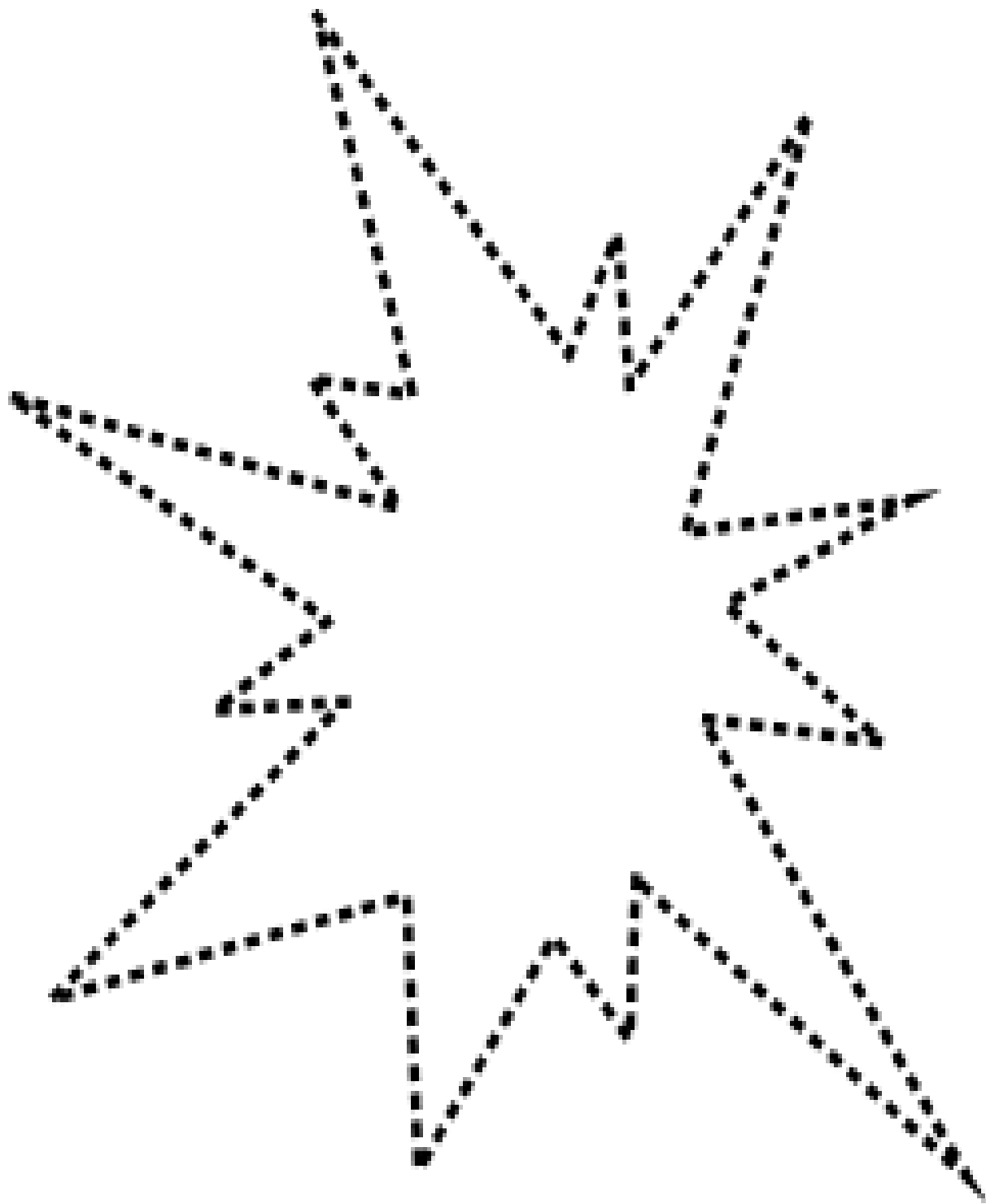

What does this look like? Trace the shapes and finish the picture.

Name: _____

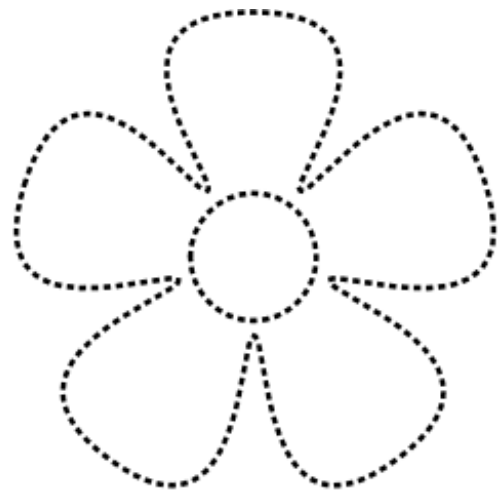
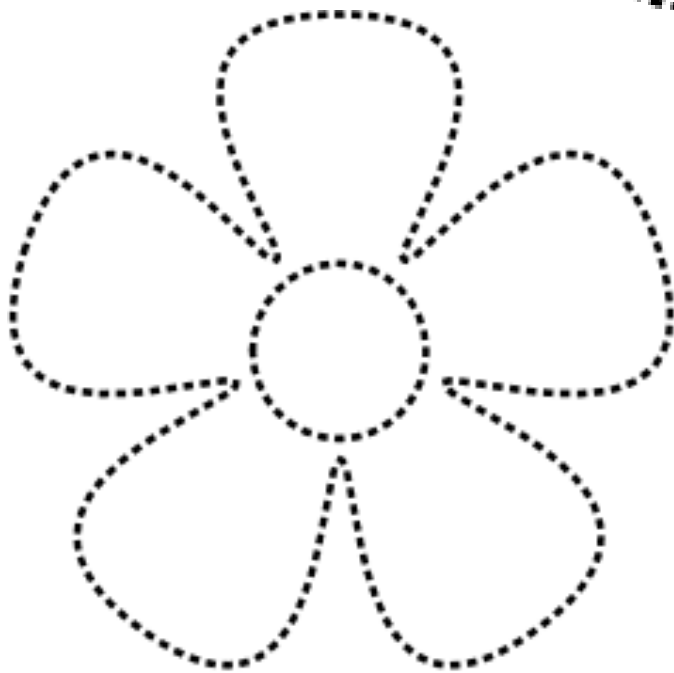
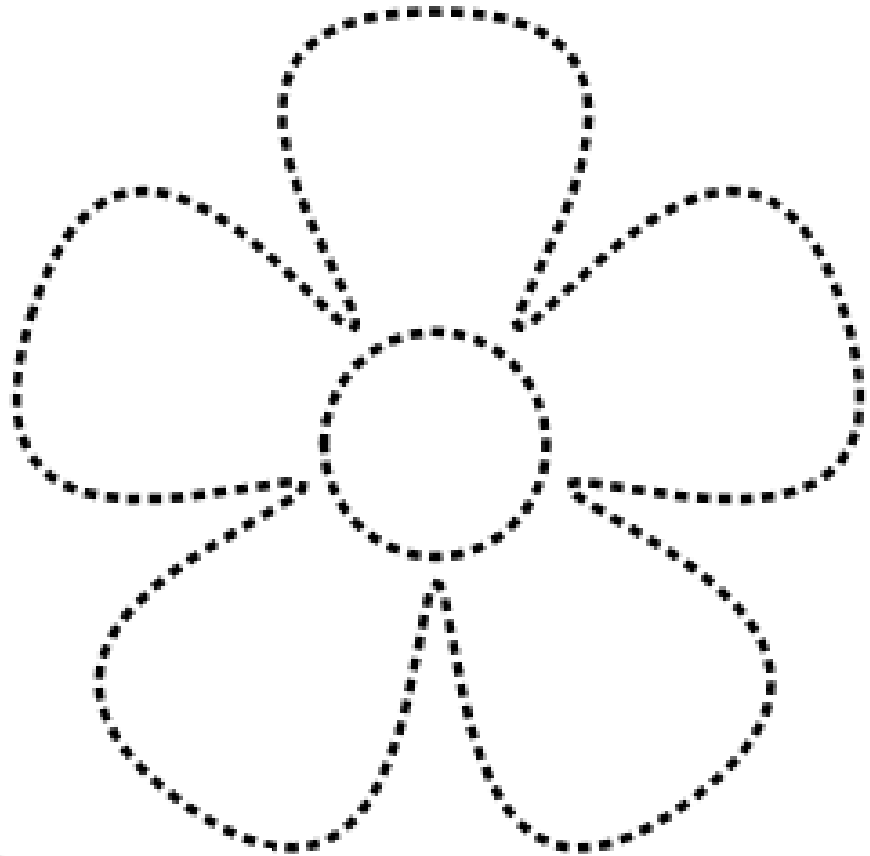

What does this look like? Trace the shapes and finish the picture.

Name: _____

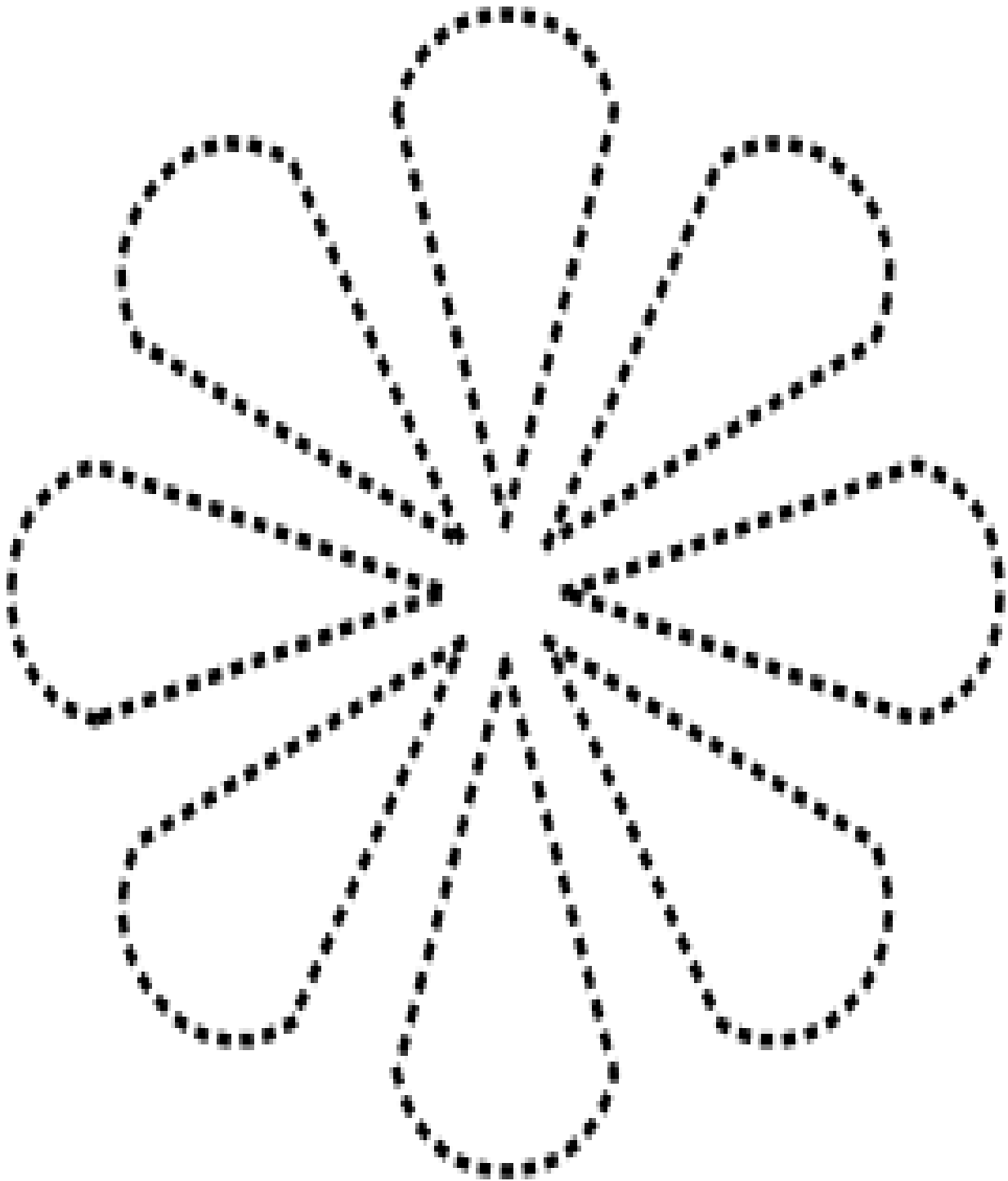

What does this look like? Trace the shapes and finish the picture.

Name: _____

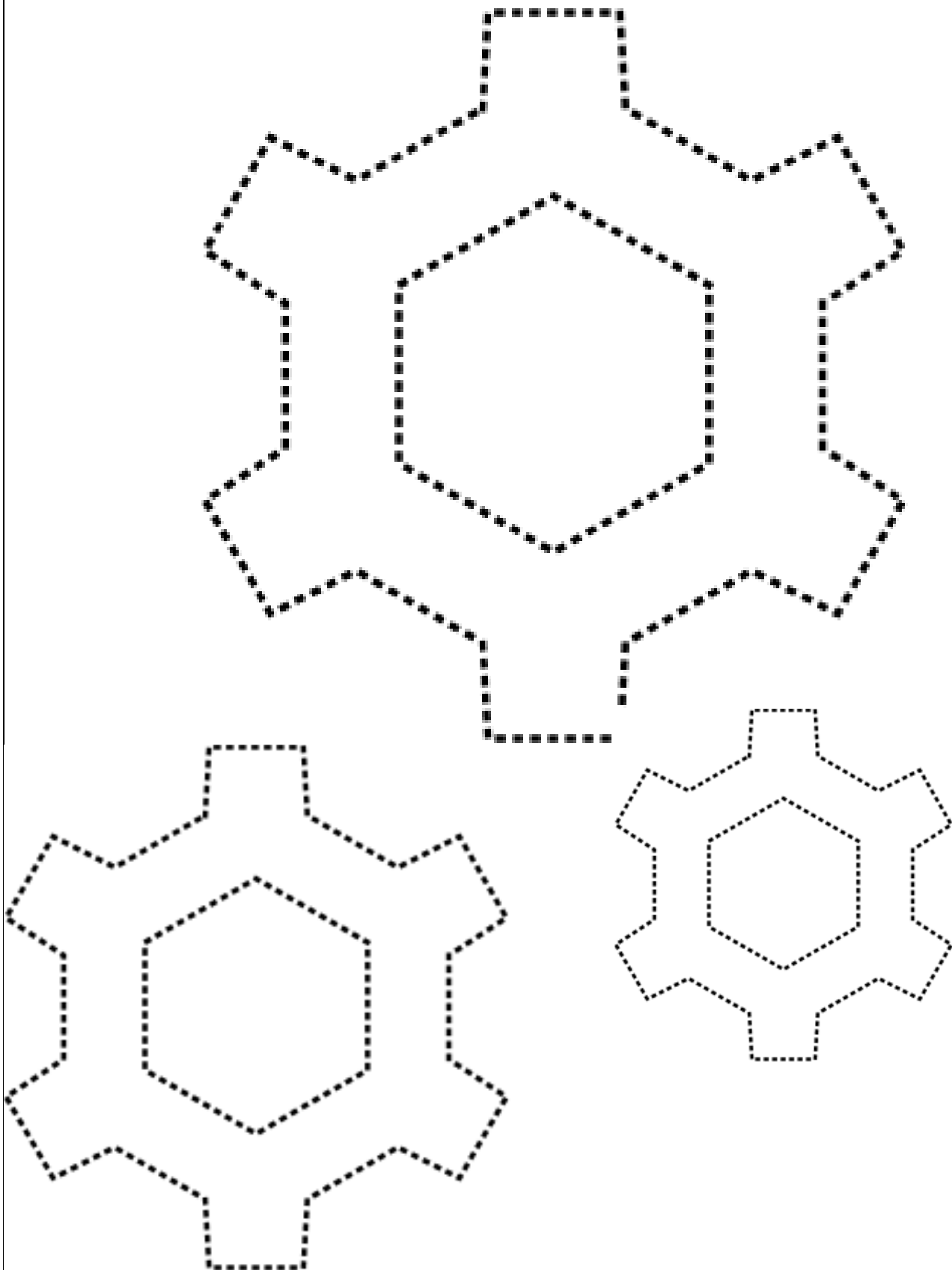

What does this look like? Trace the shapes and finish the picture.

Name: _____

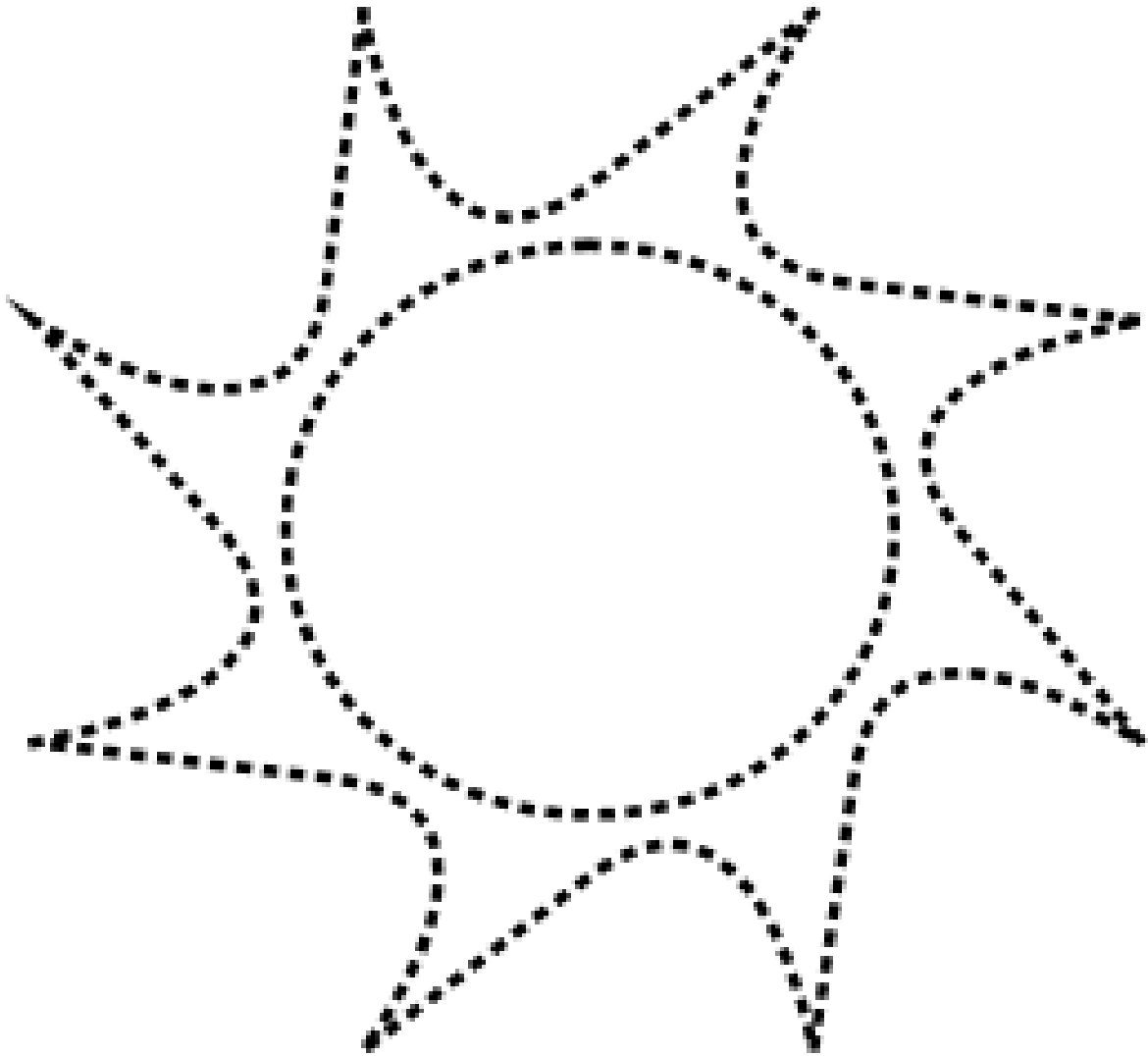

What does this look like? Trace the shapes and finish the picture.

Name: _____

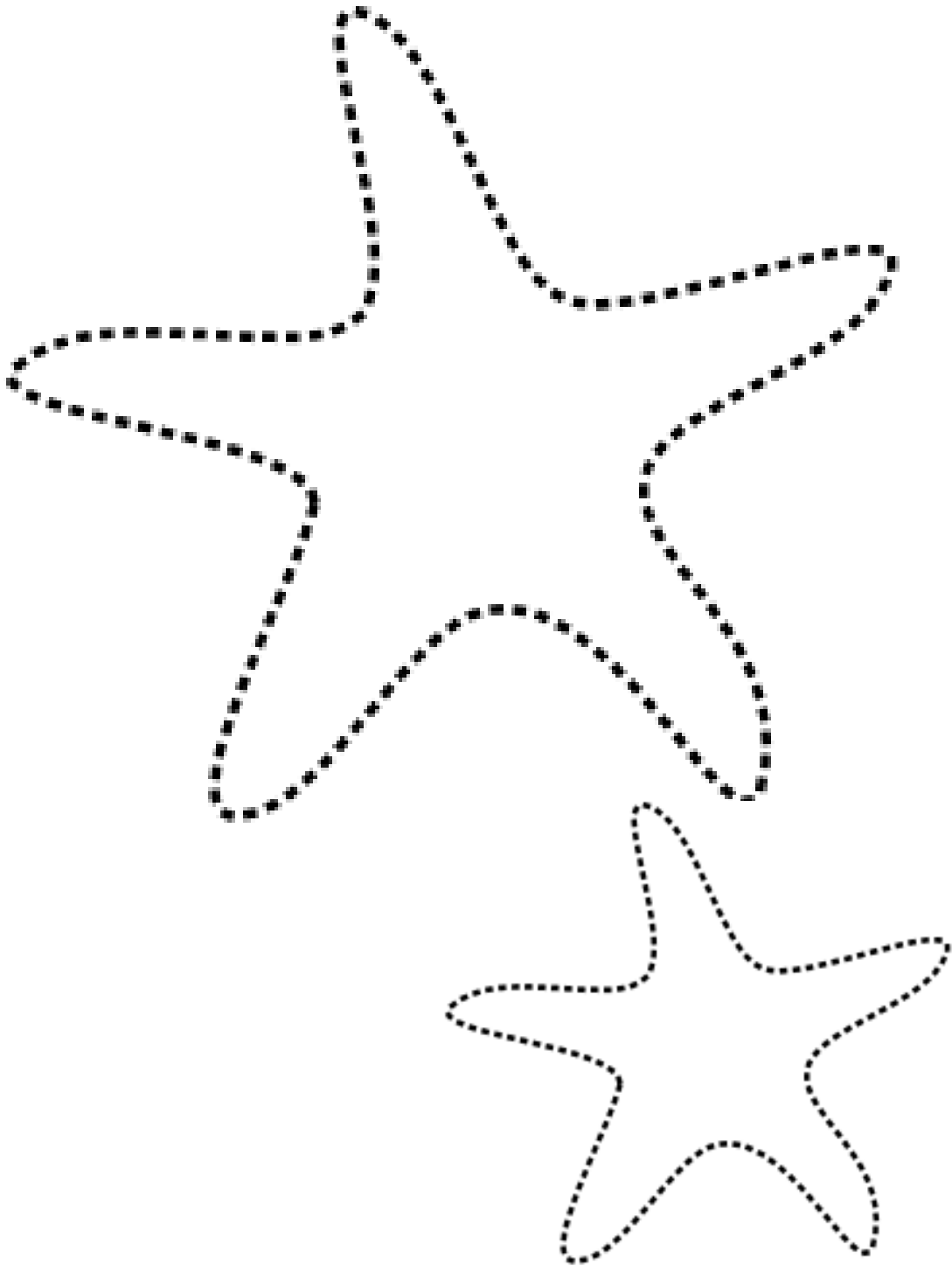

What does this look like? Trace the shapes and finish the picture.

Name: _____

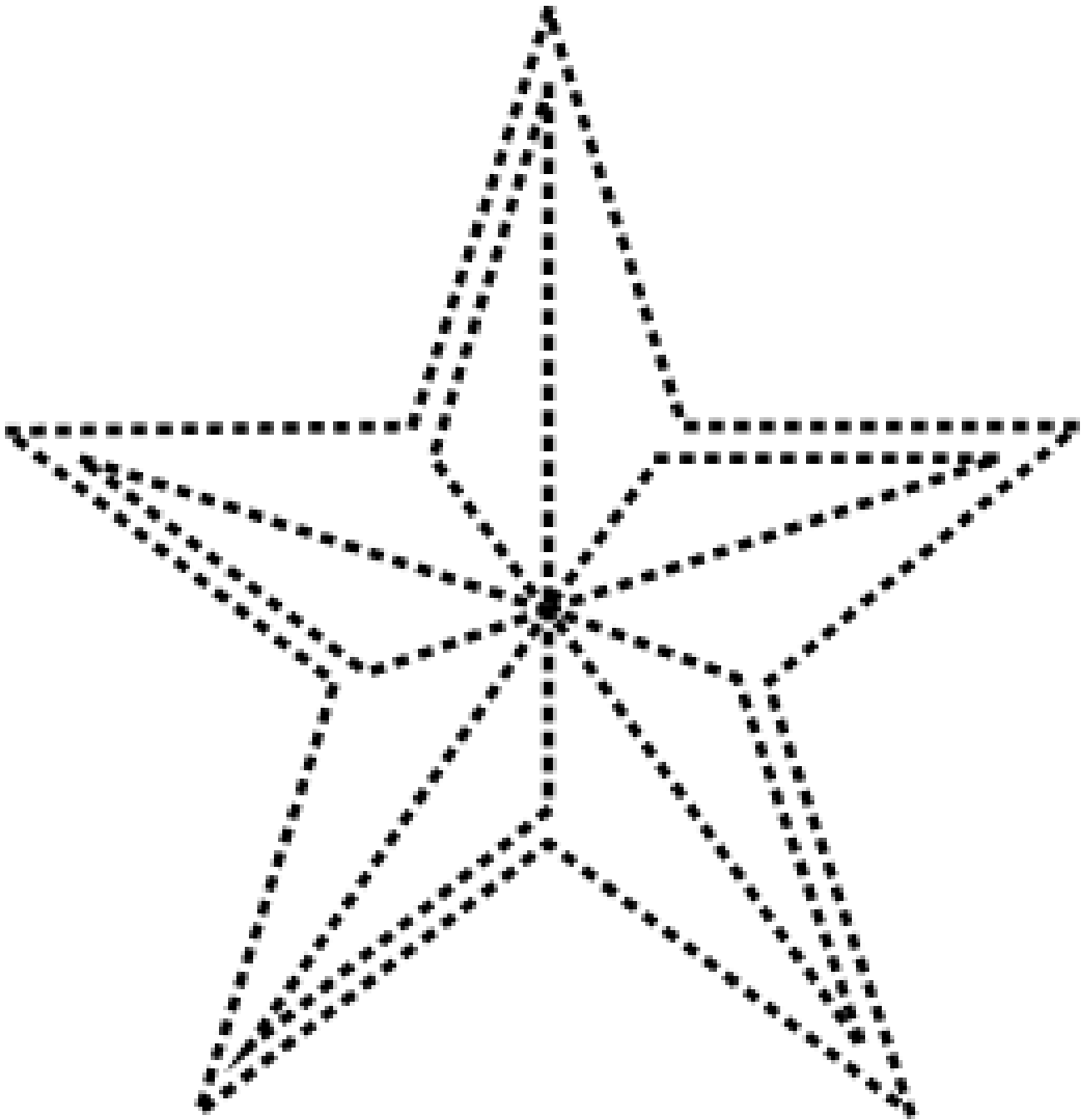

What does this look like? Trace the shapes and finish the picture.

Name: _____

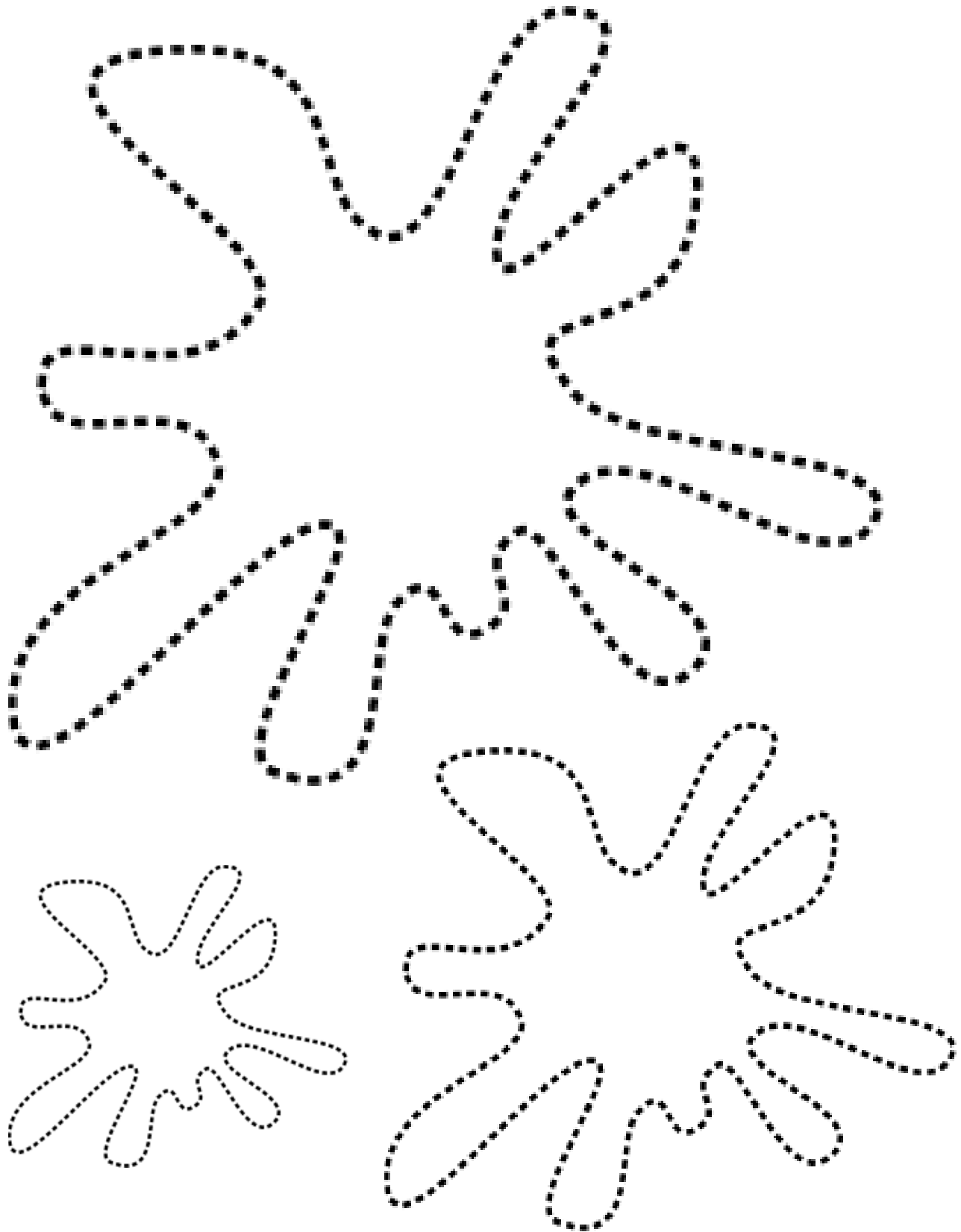

What does this look like? Trace the shapes and finish the picture.

Name: _____

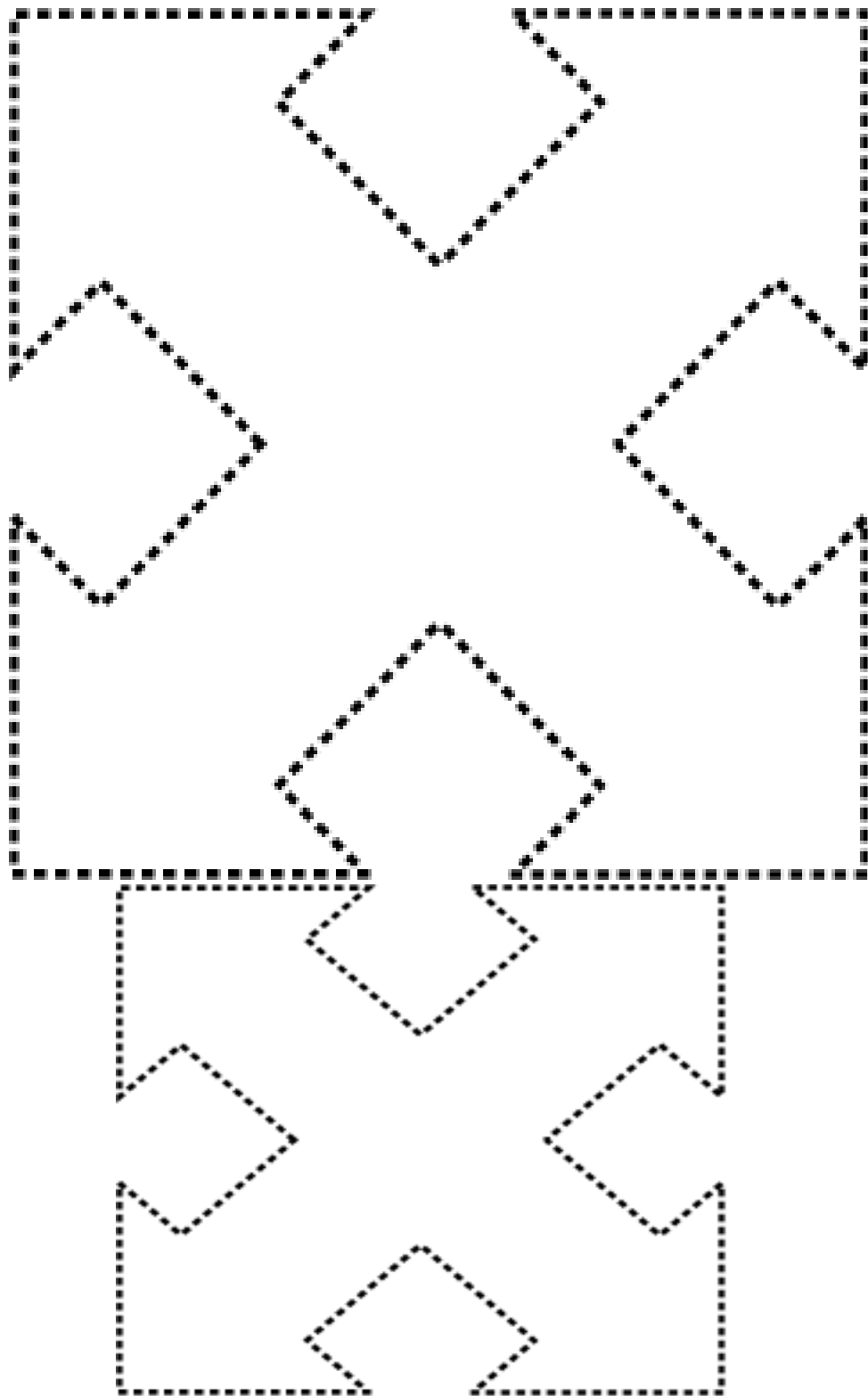

What does this look like? Trace the shapes and finish the picture.

Name: _____

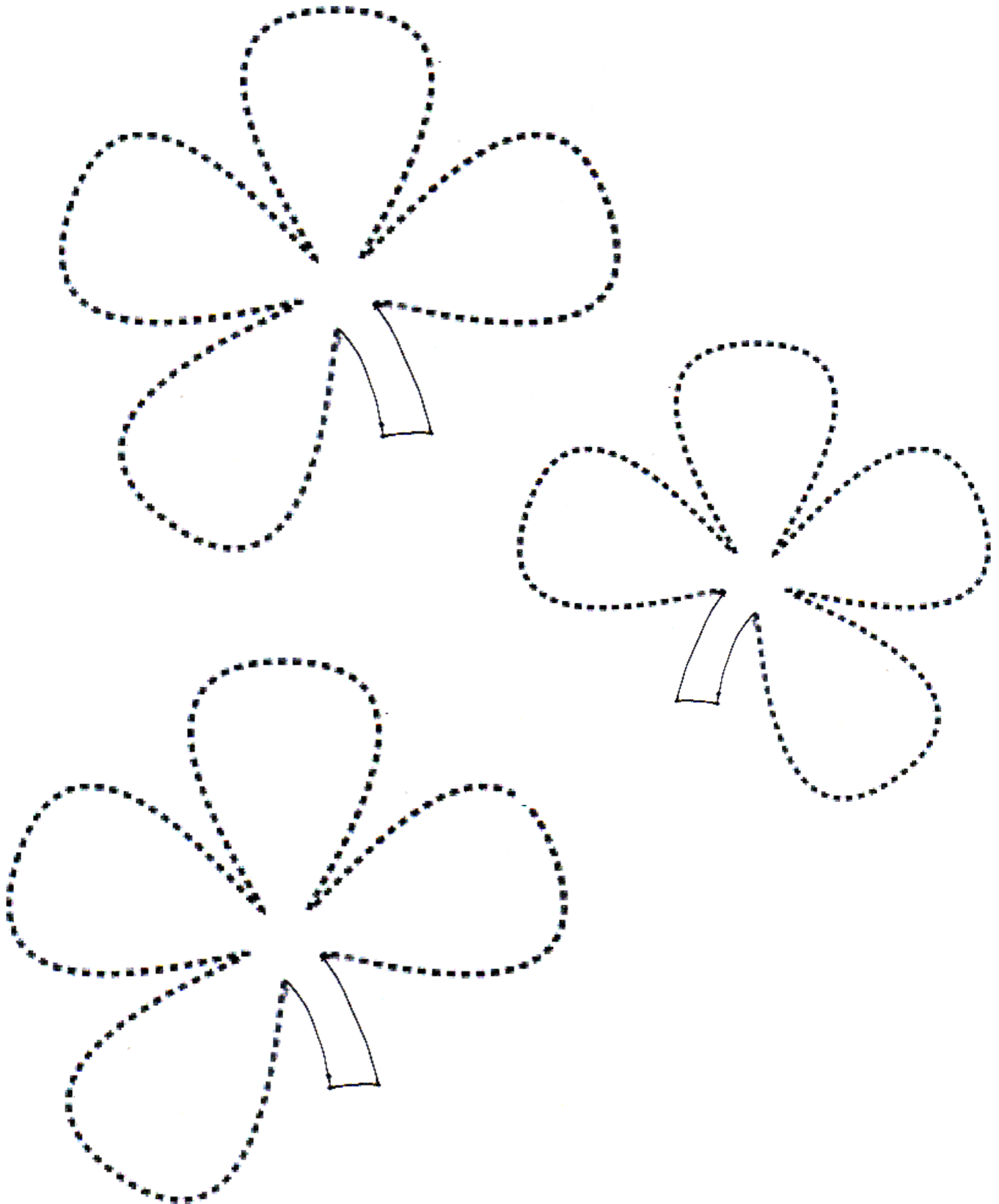

What does this look like? Trace the shapes and finish the picture.

Name: _____

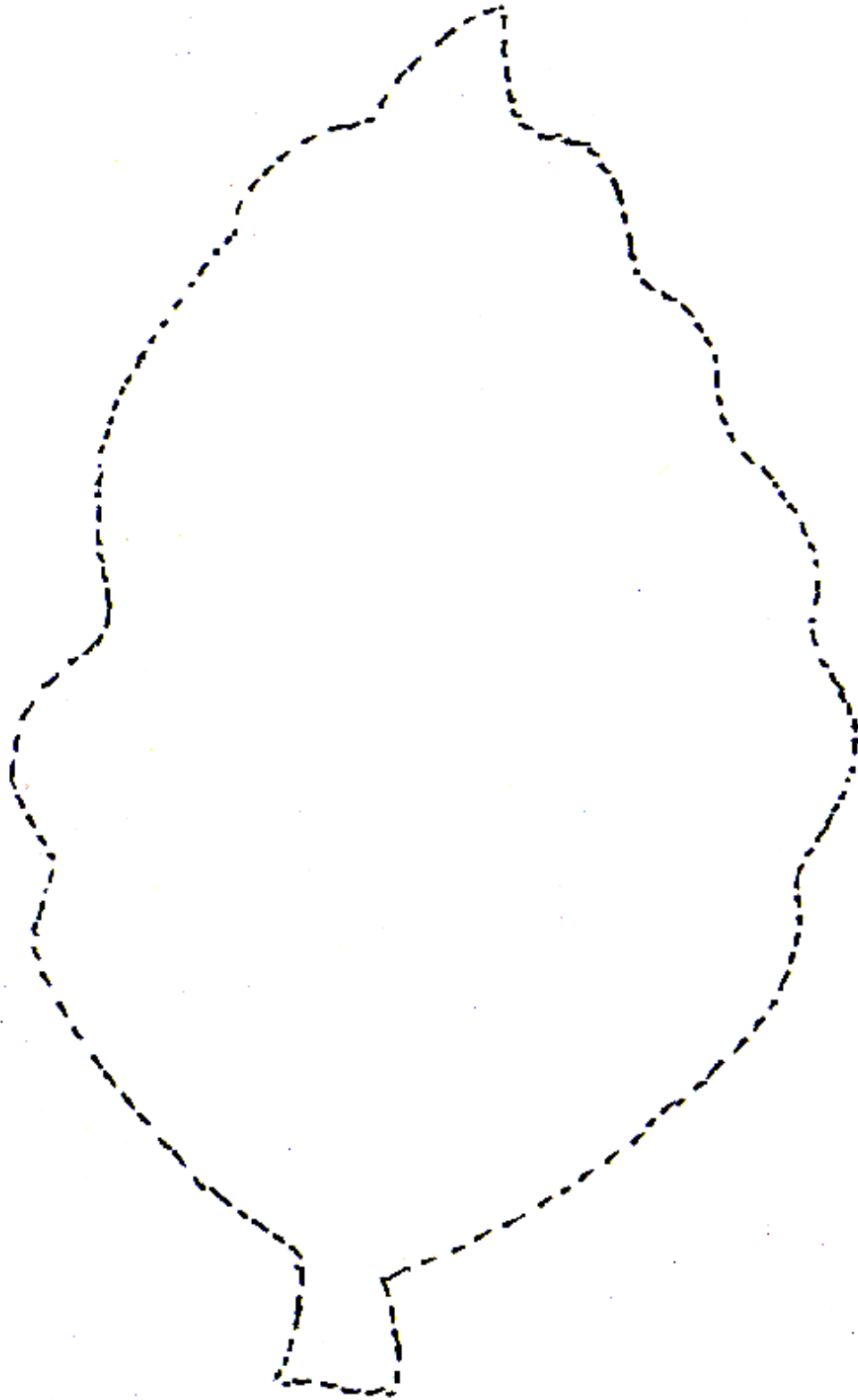

leaf 1

Name: _____

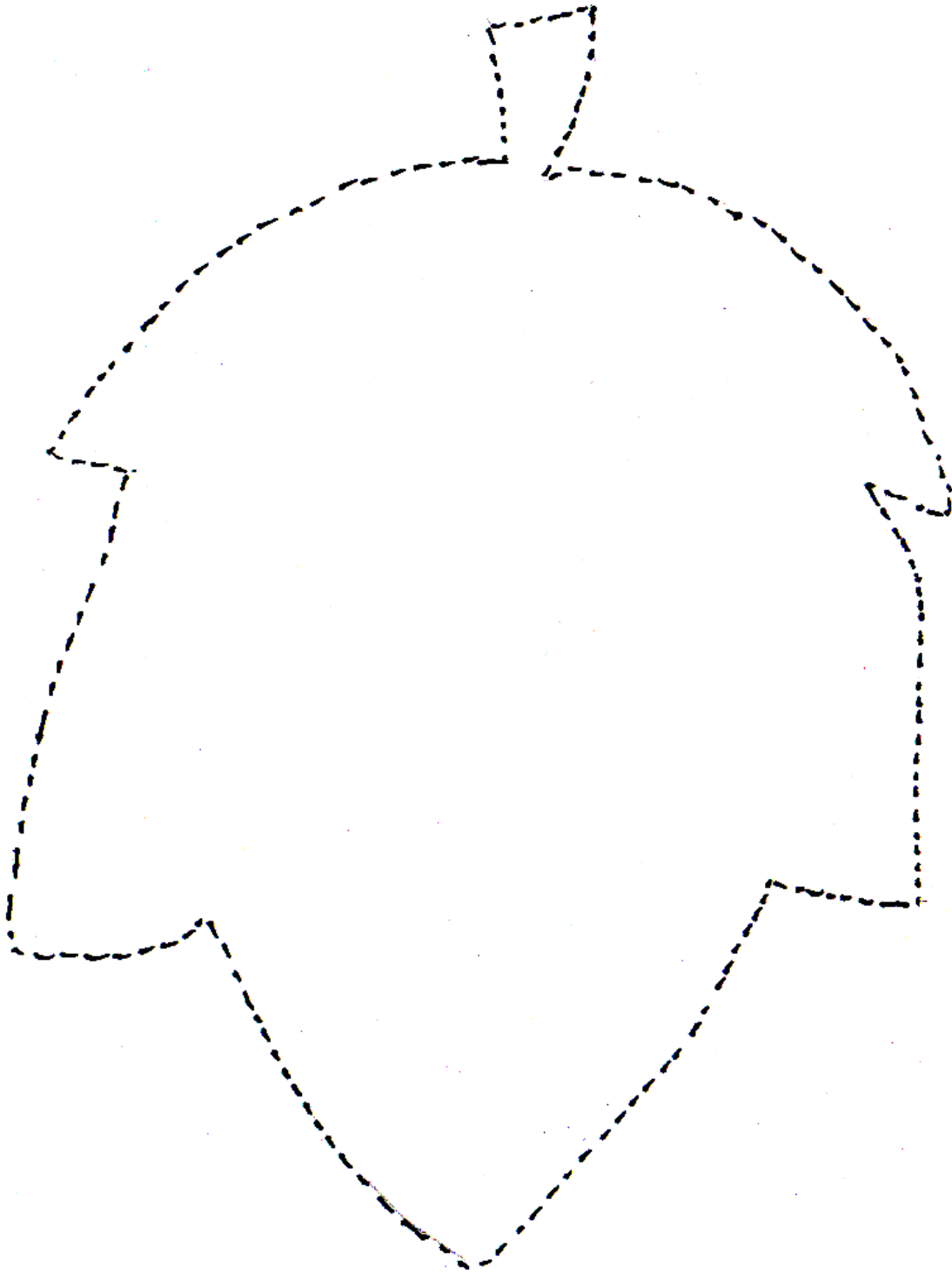

leaf 2

Name: _____

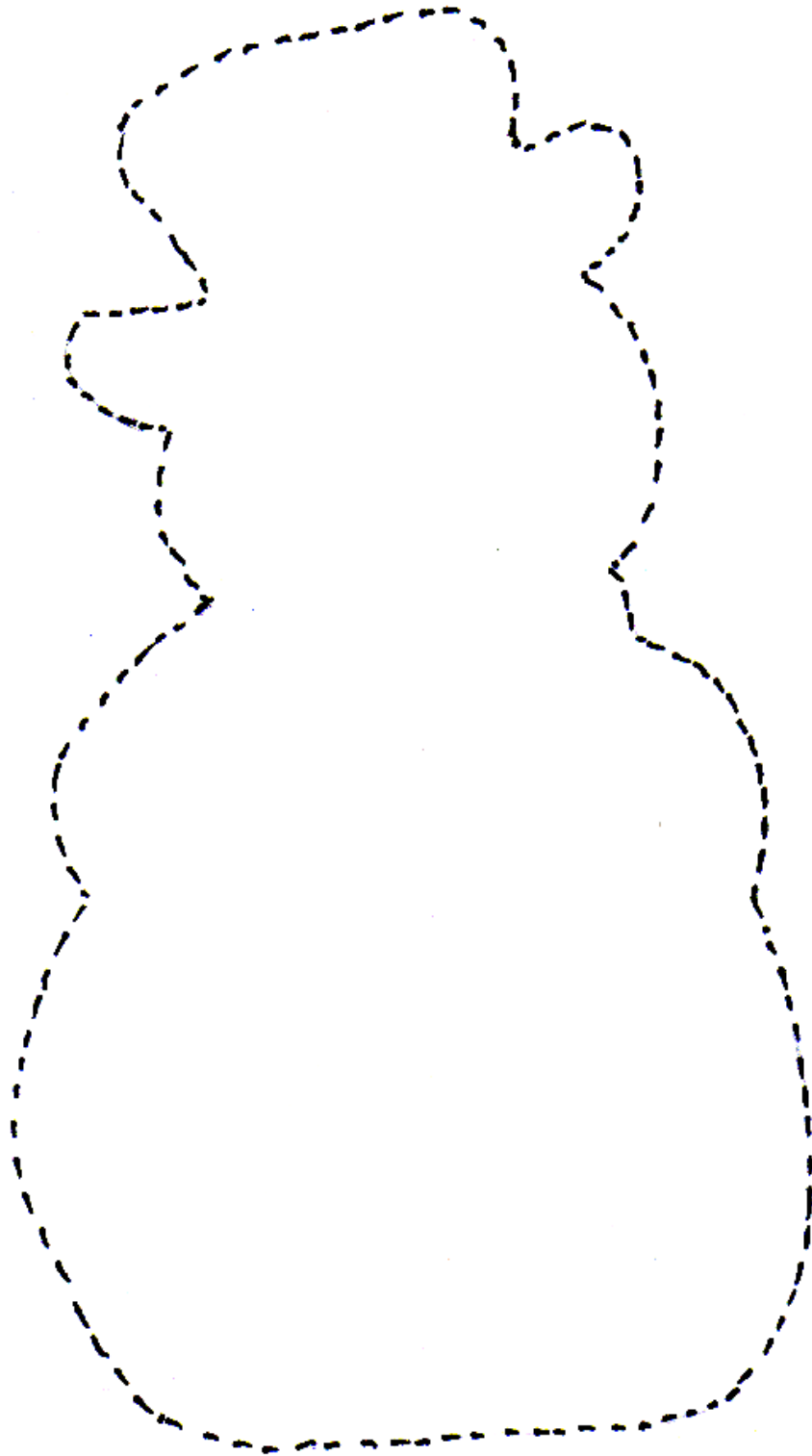

snowman

Name: _____

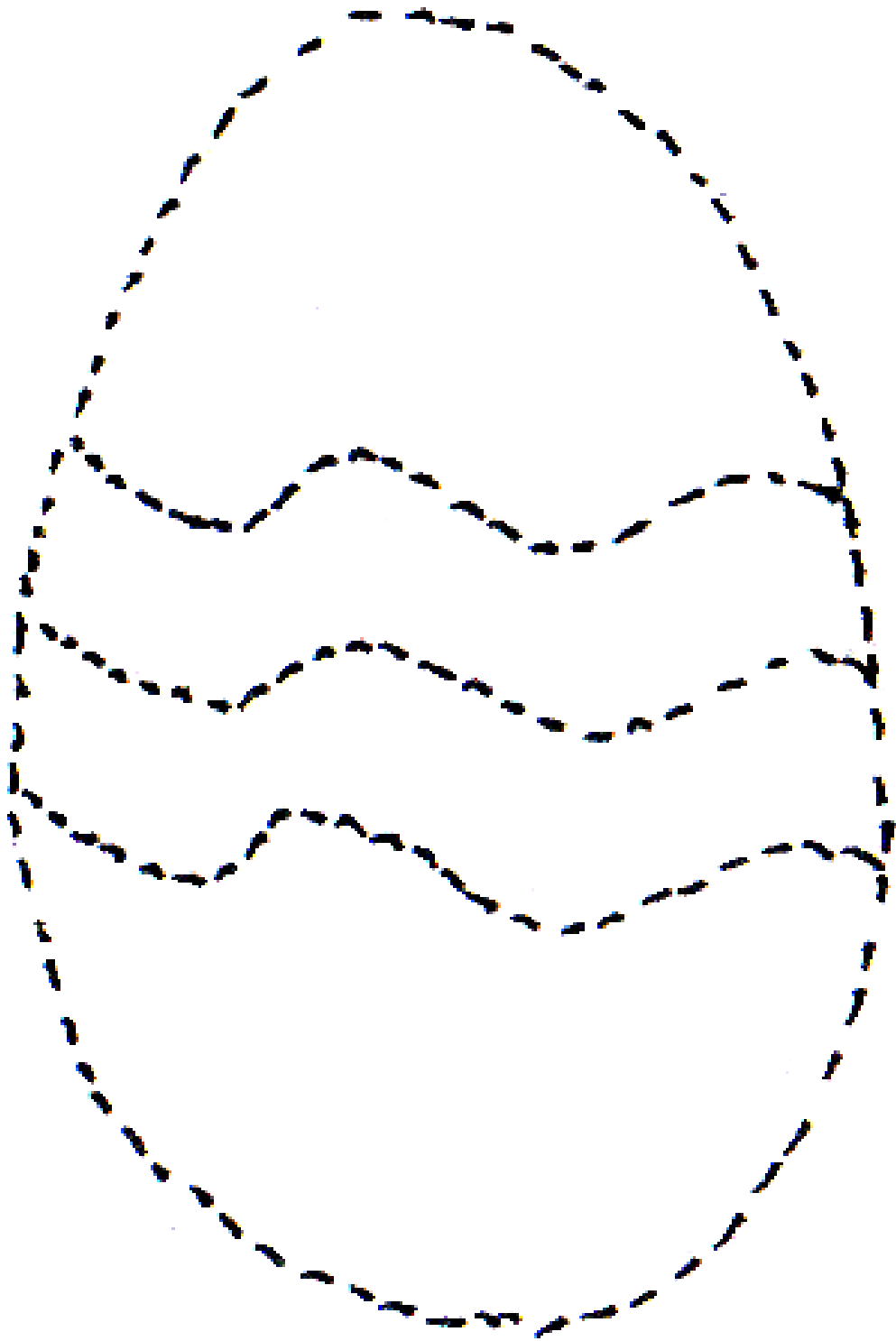

egg

Name: _____

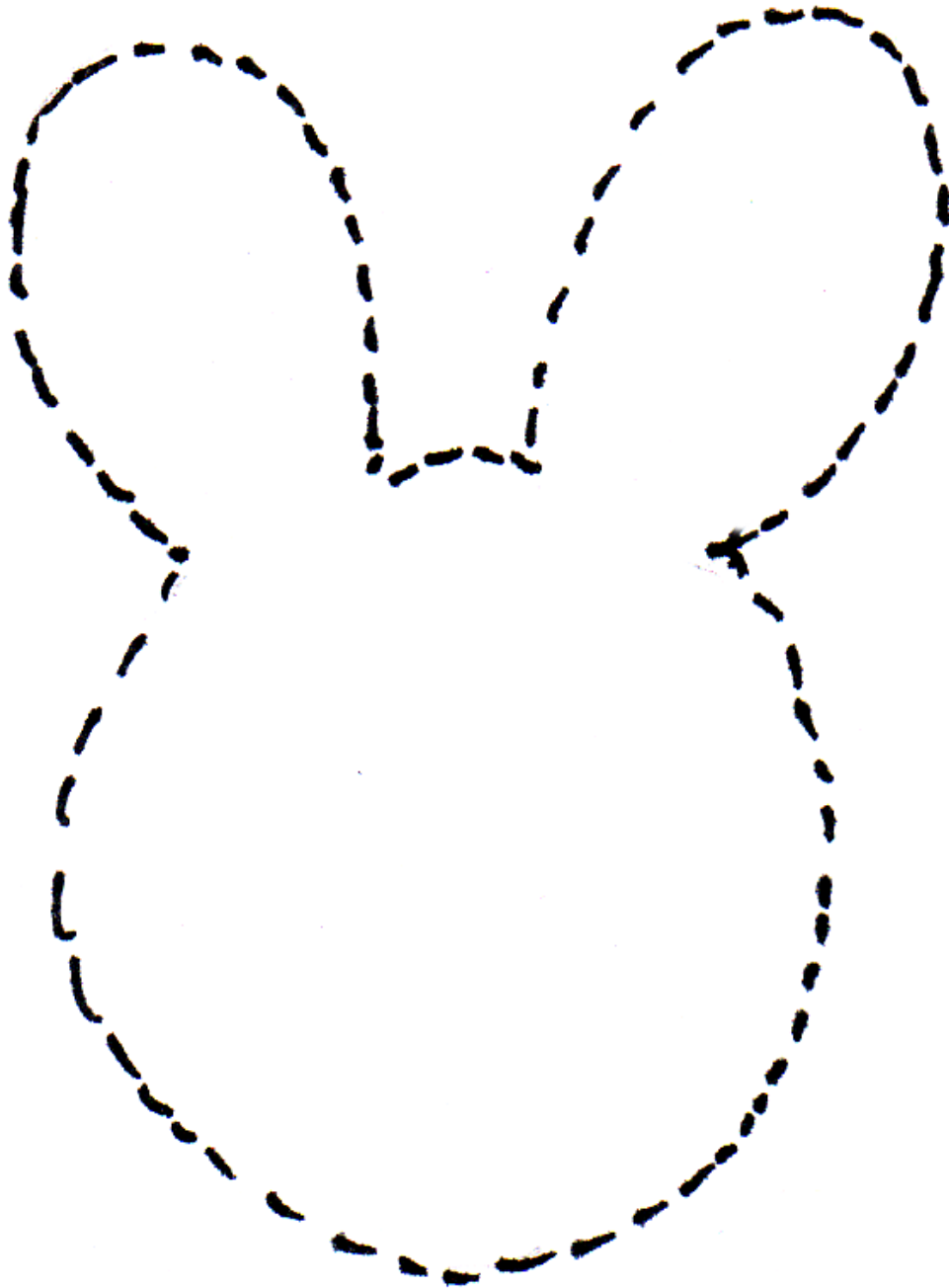

bunny

Name: _____

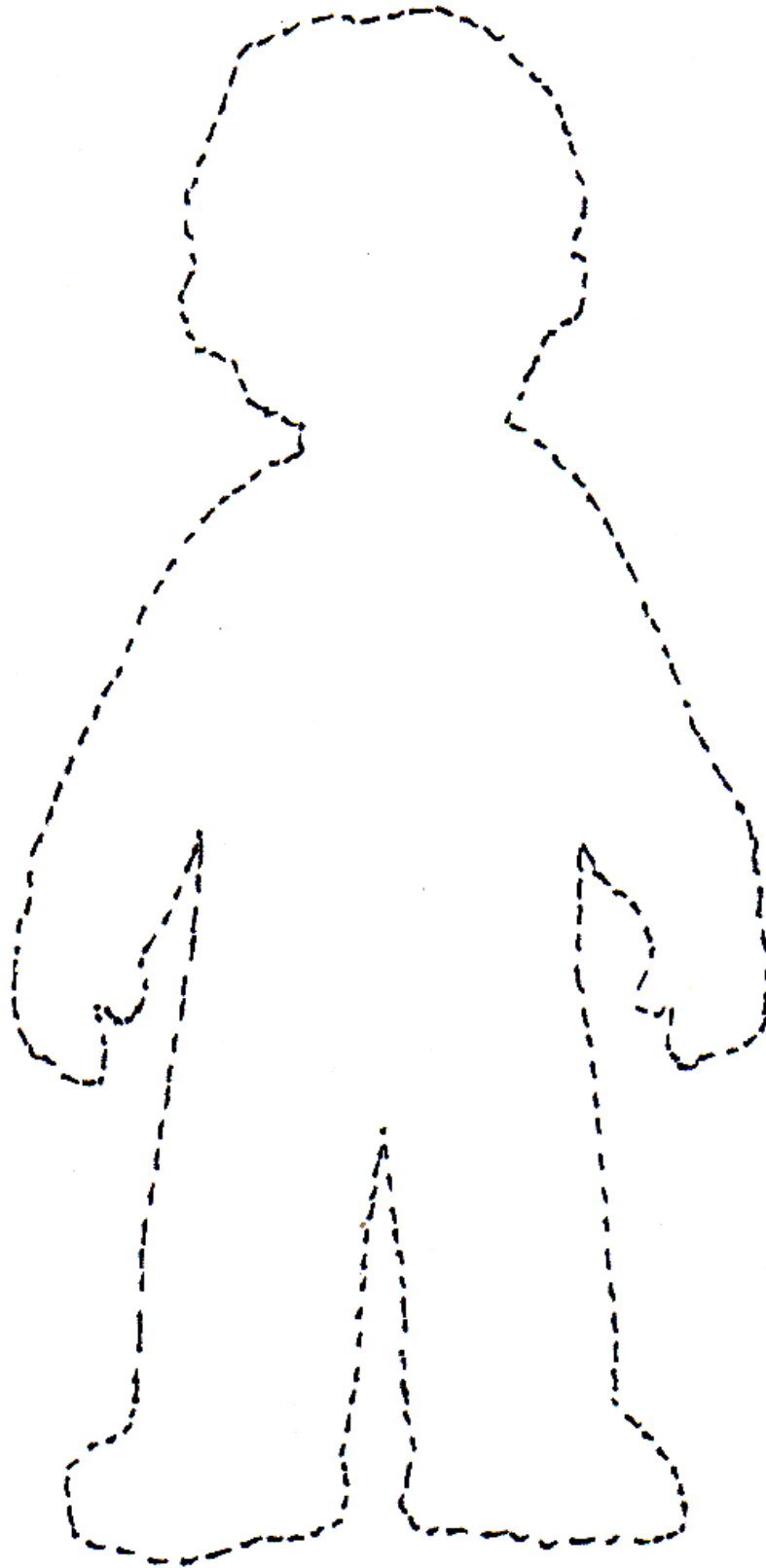

child

Name: _____

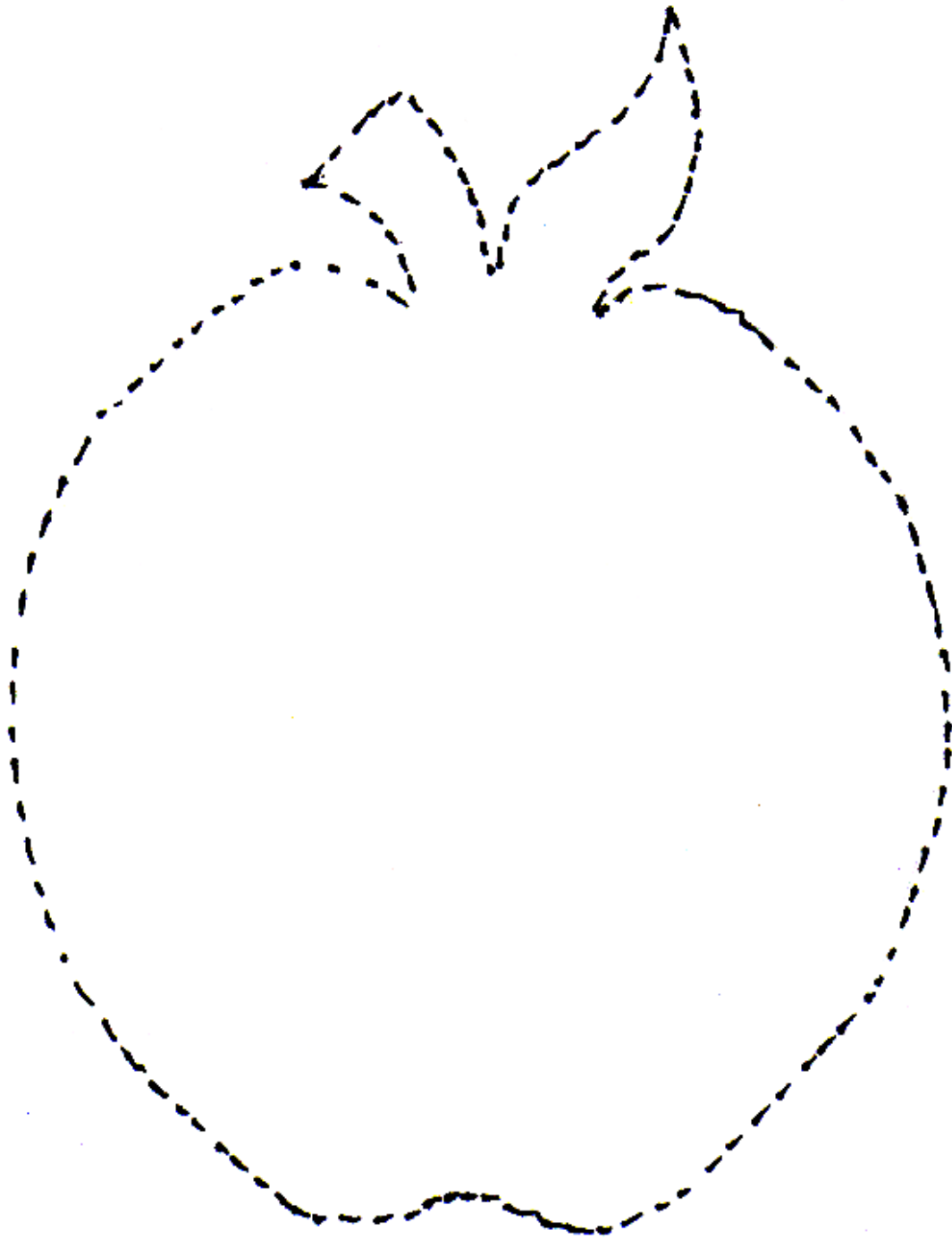

apple

Name: _____

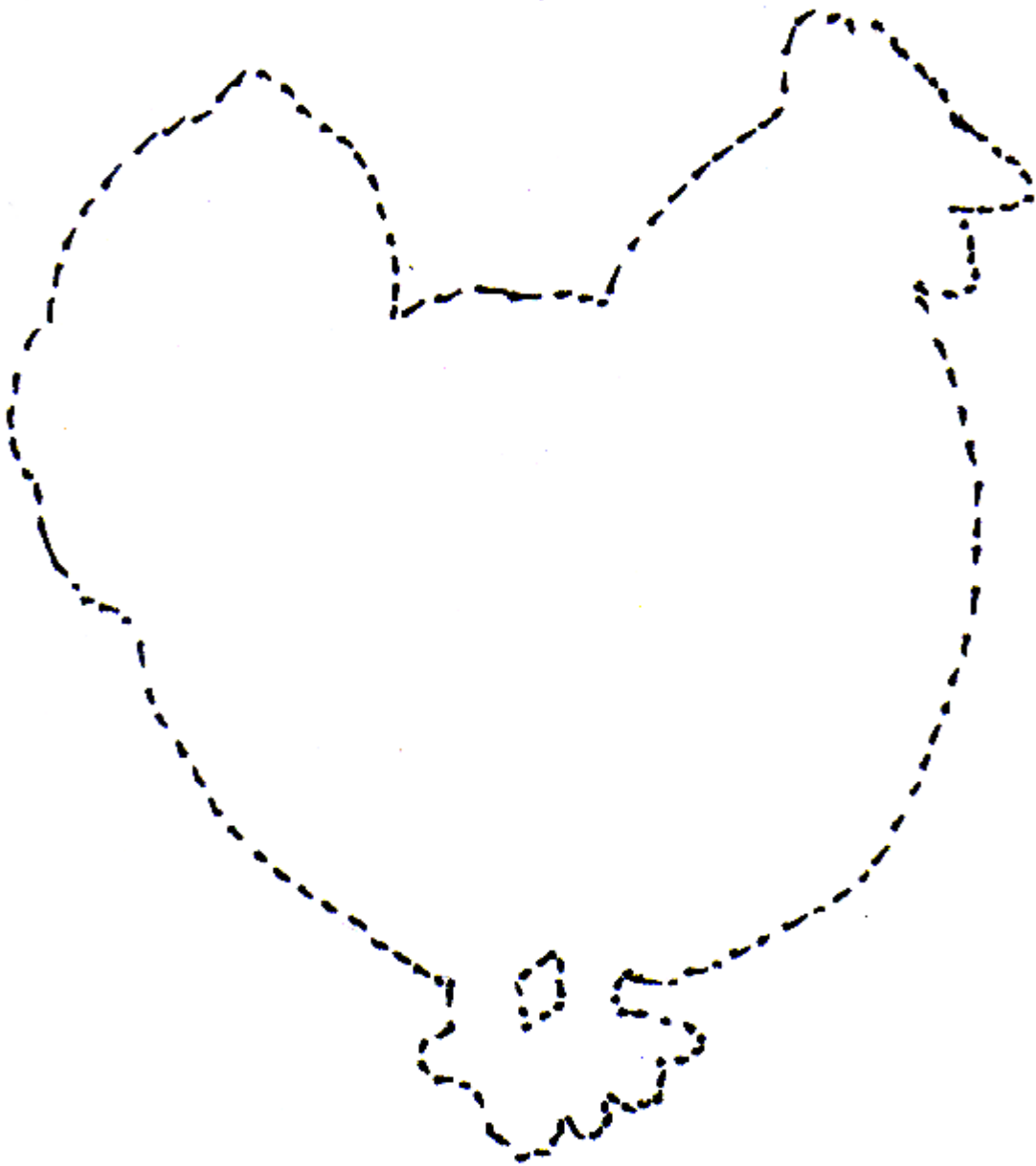

chicken

Name: _____

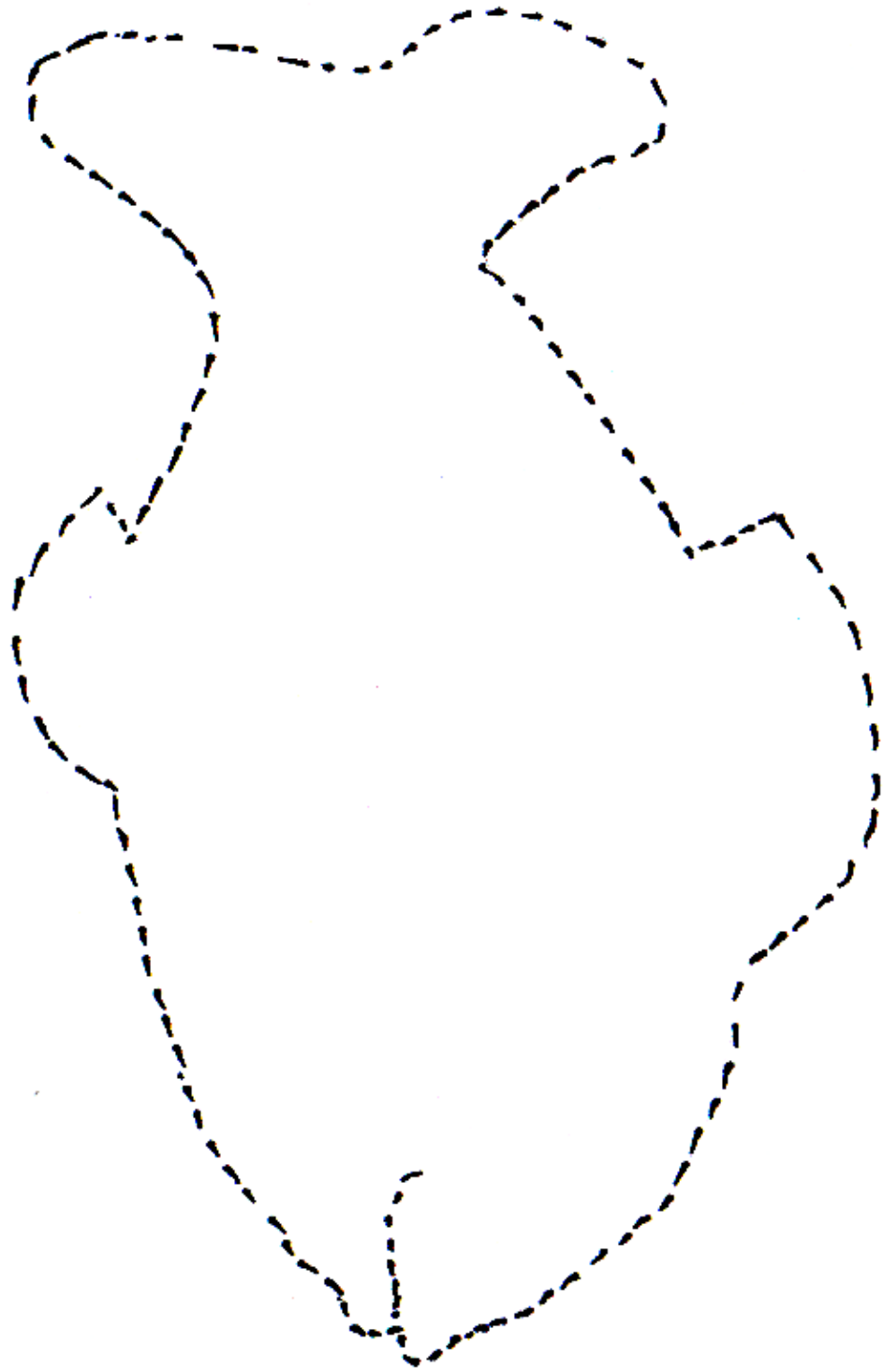

fish

Name: _____

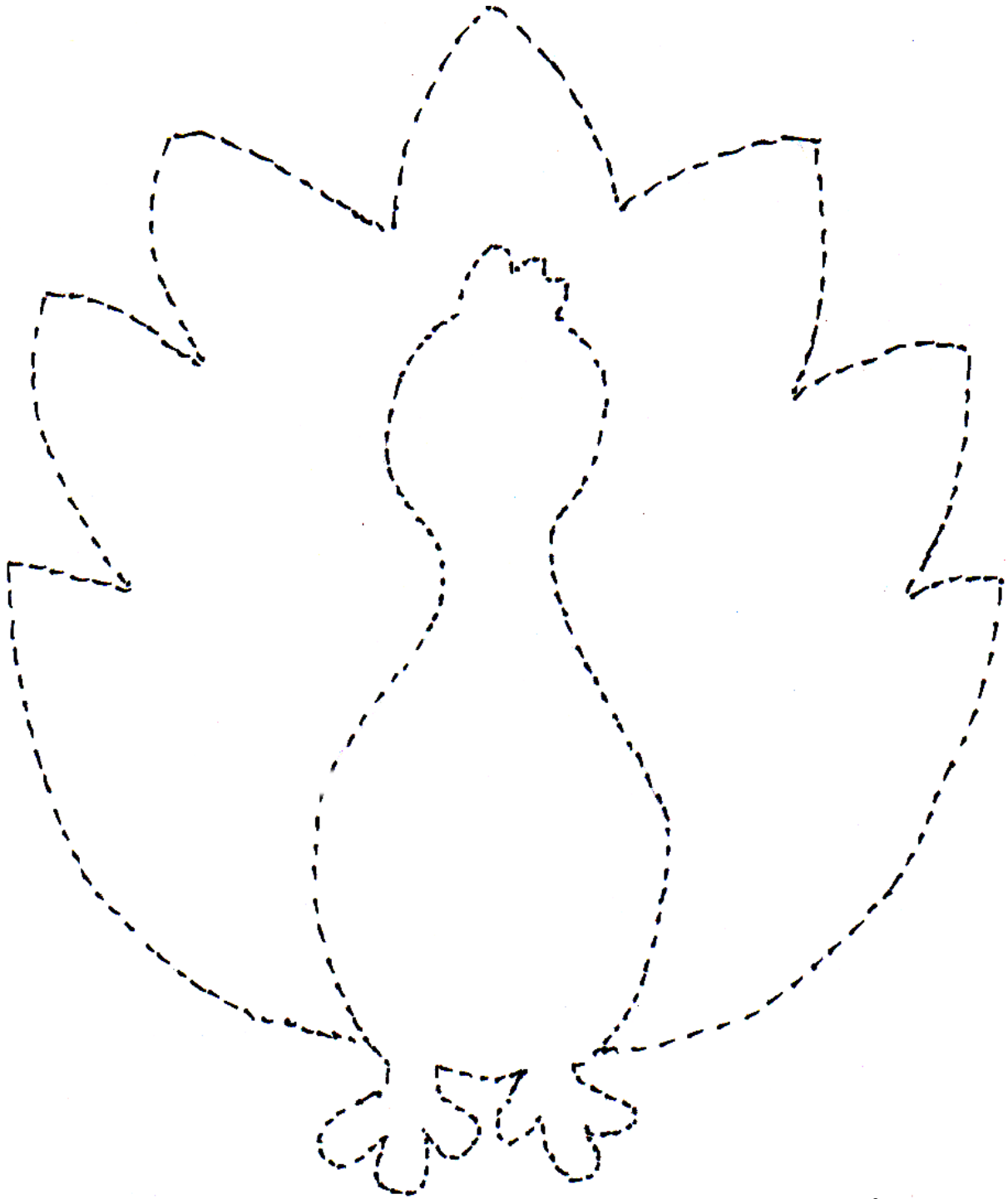

turkey

Name: _____

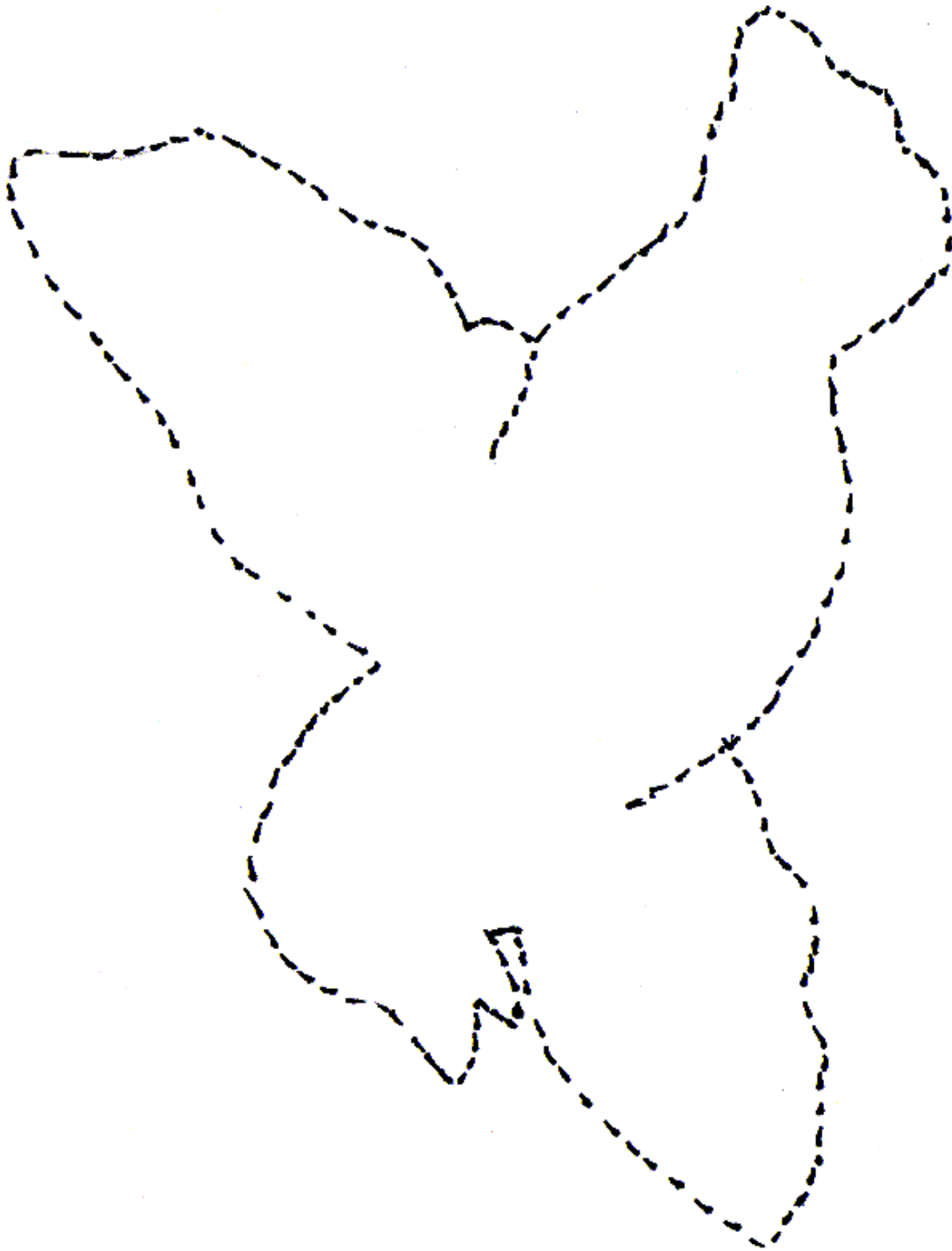

bird

Name: _____

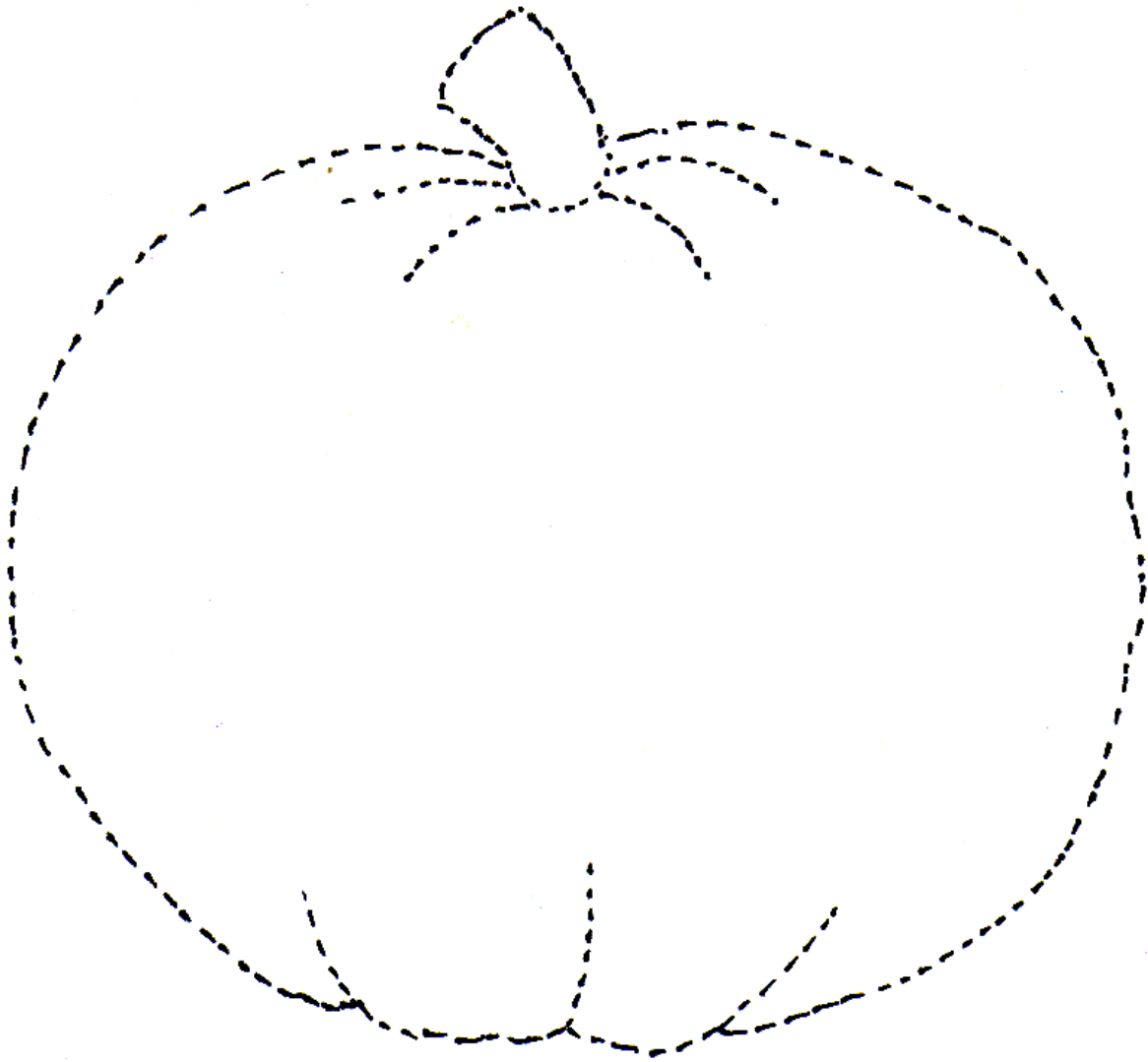

pumpkin

Name: _____

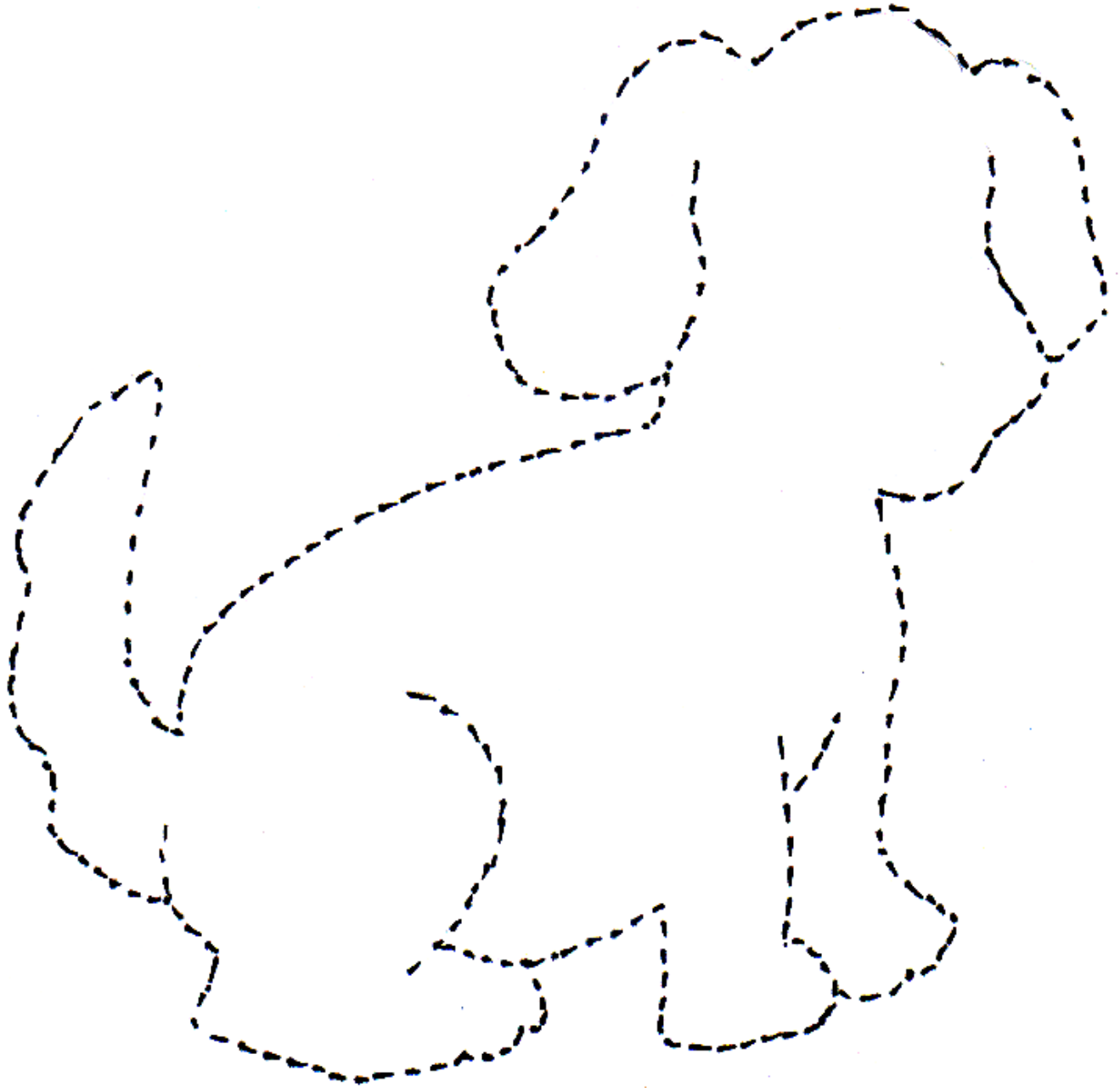

dog

Name: _____



cat

Name: _____

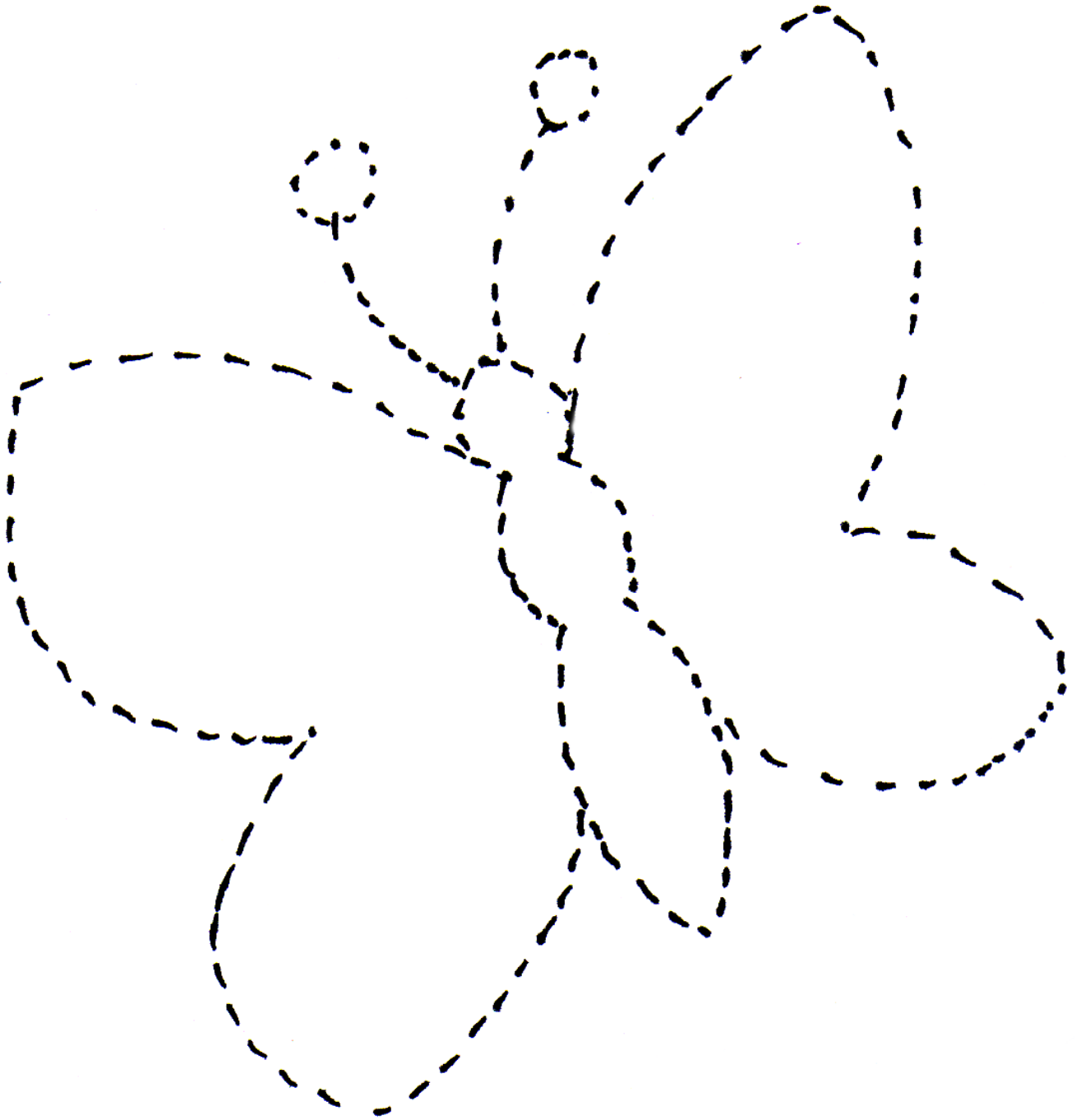

butterfly

Name: _____

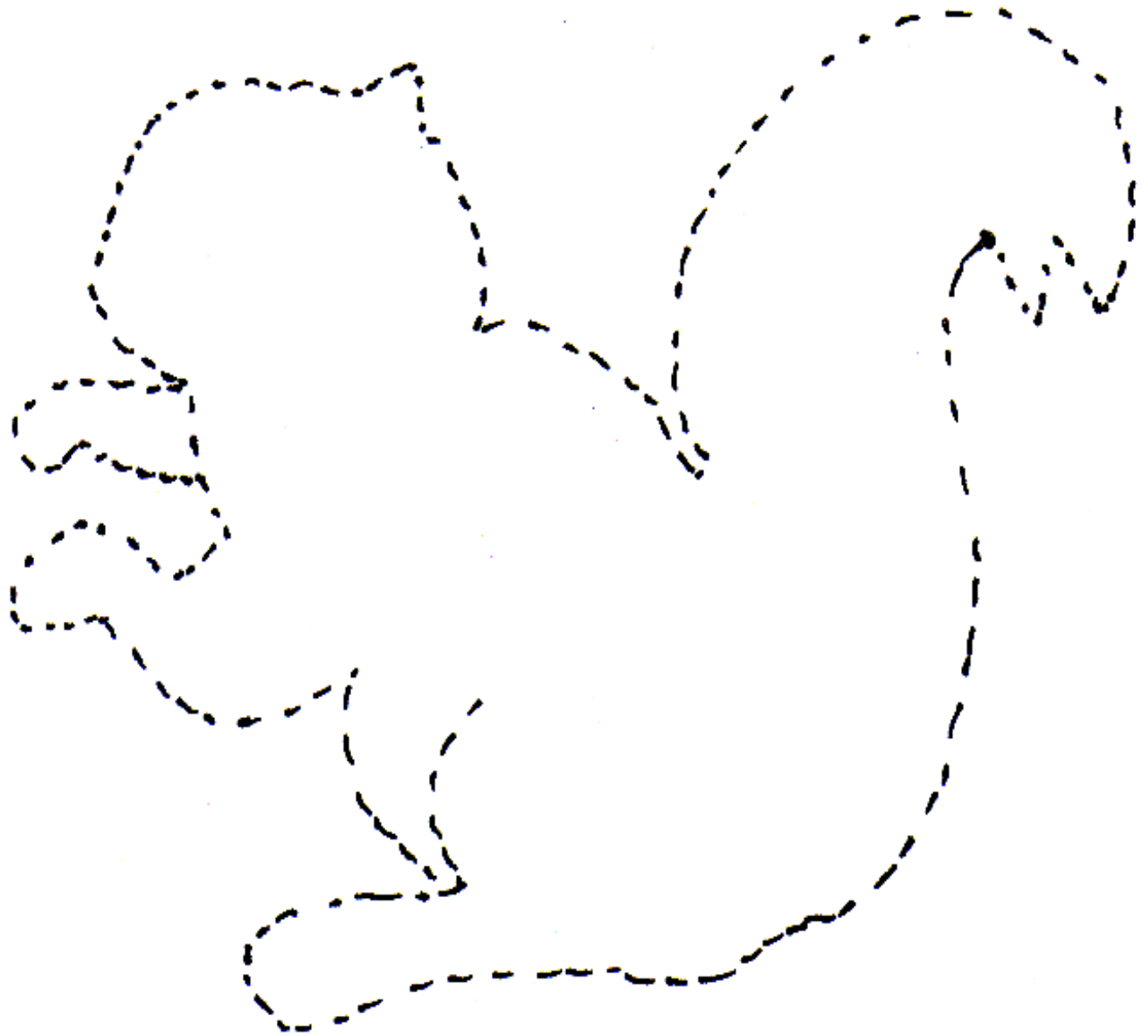

squirrel

Name: _____

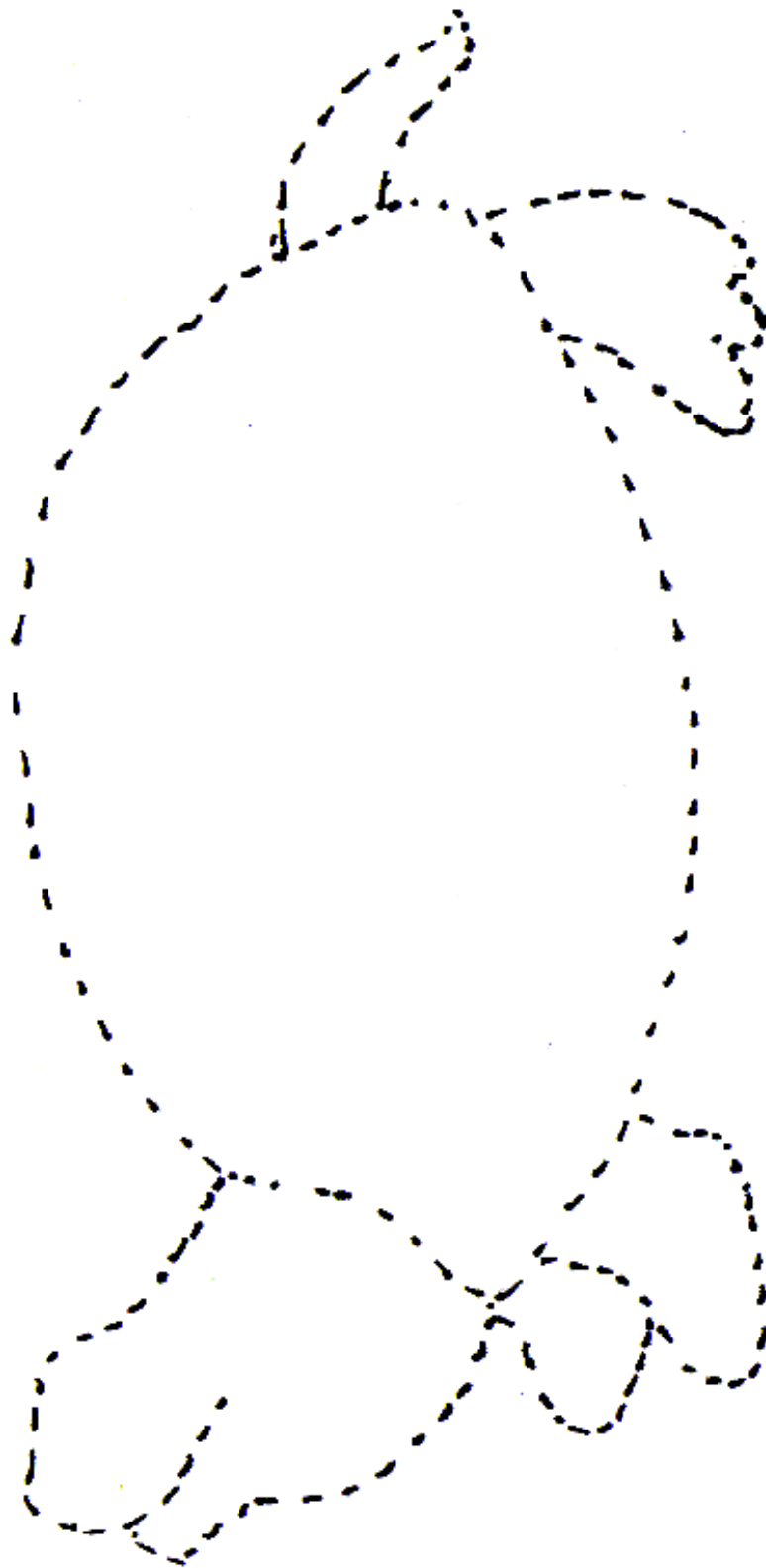

turtle

Name: _____

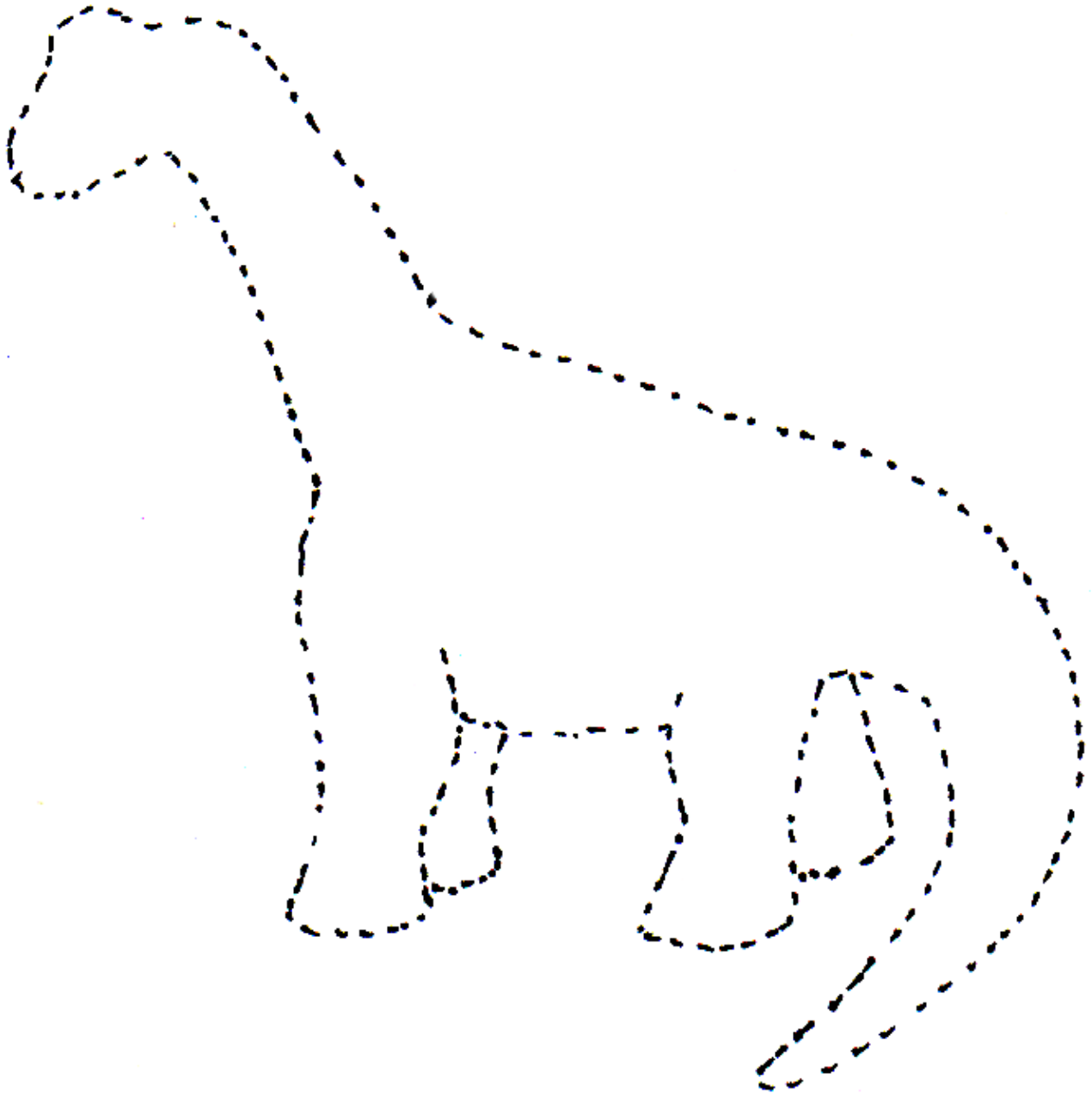

dinosaur

Name: _____

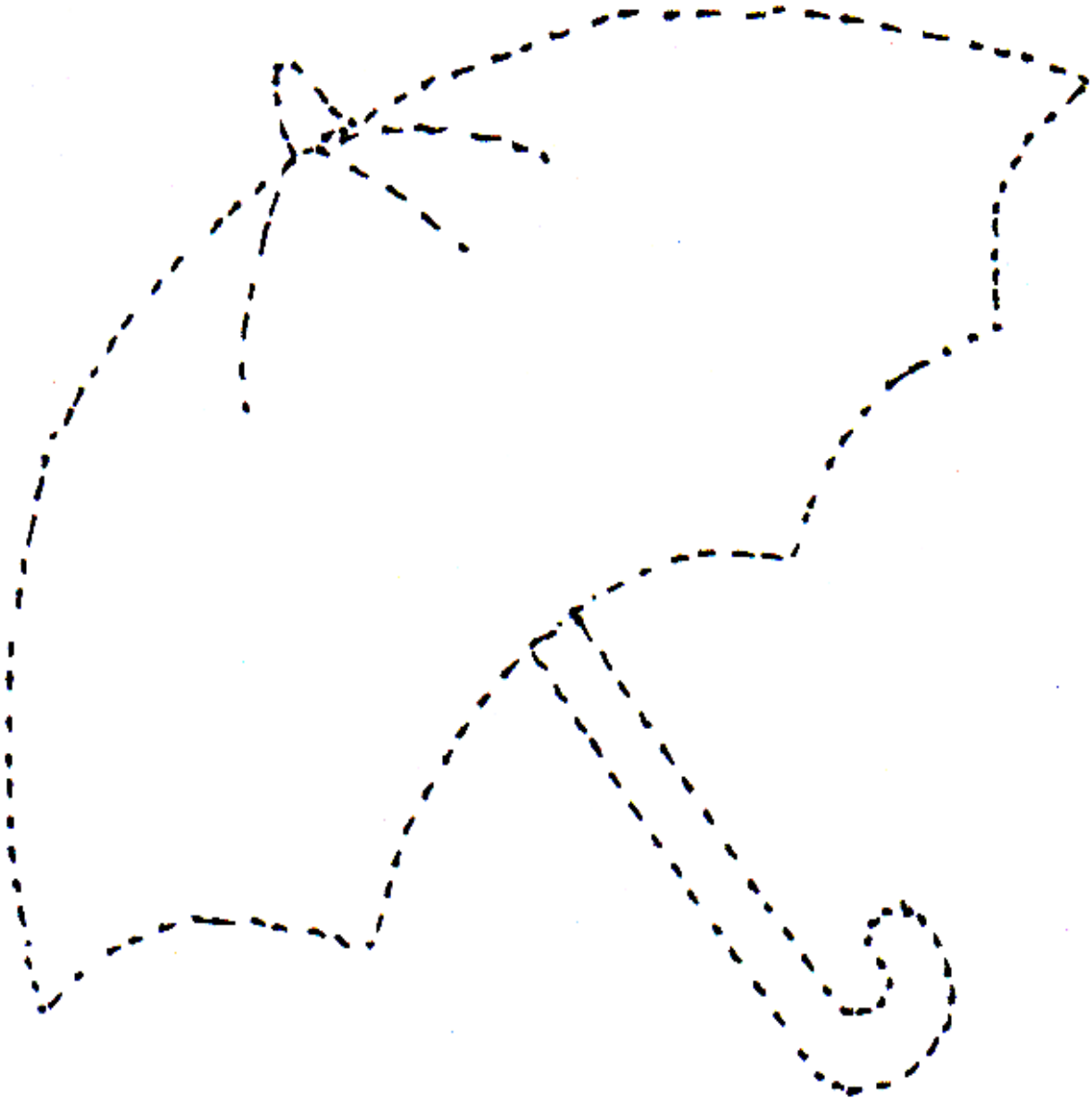

umbrella

Name: _____

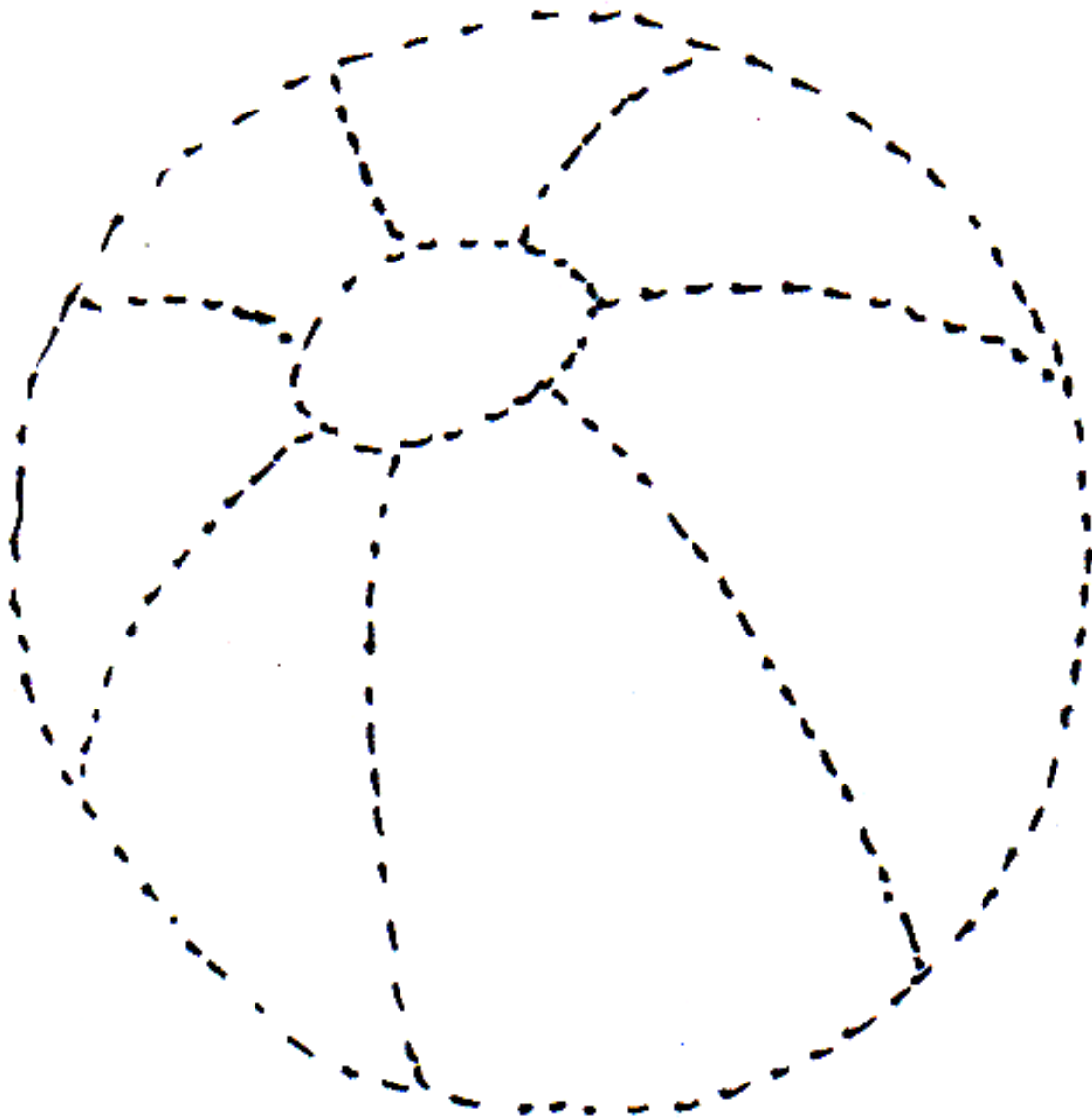

ball

Name: _____

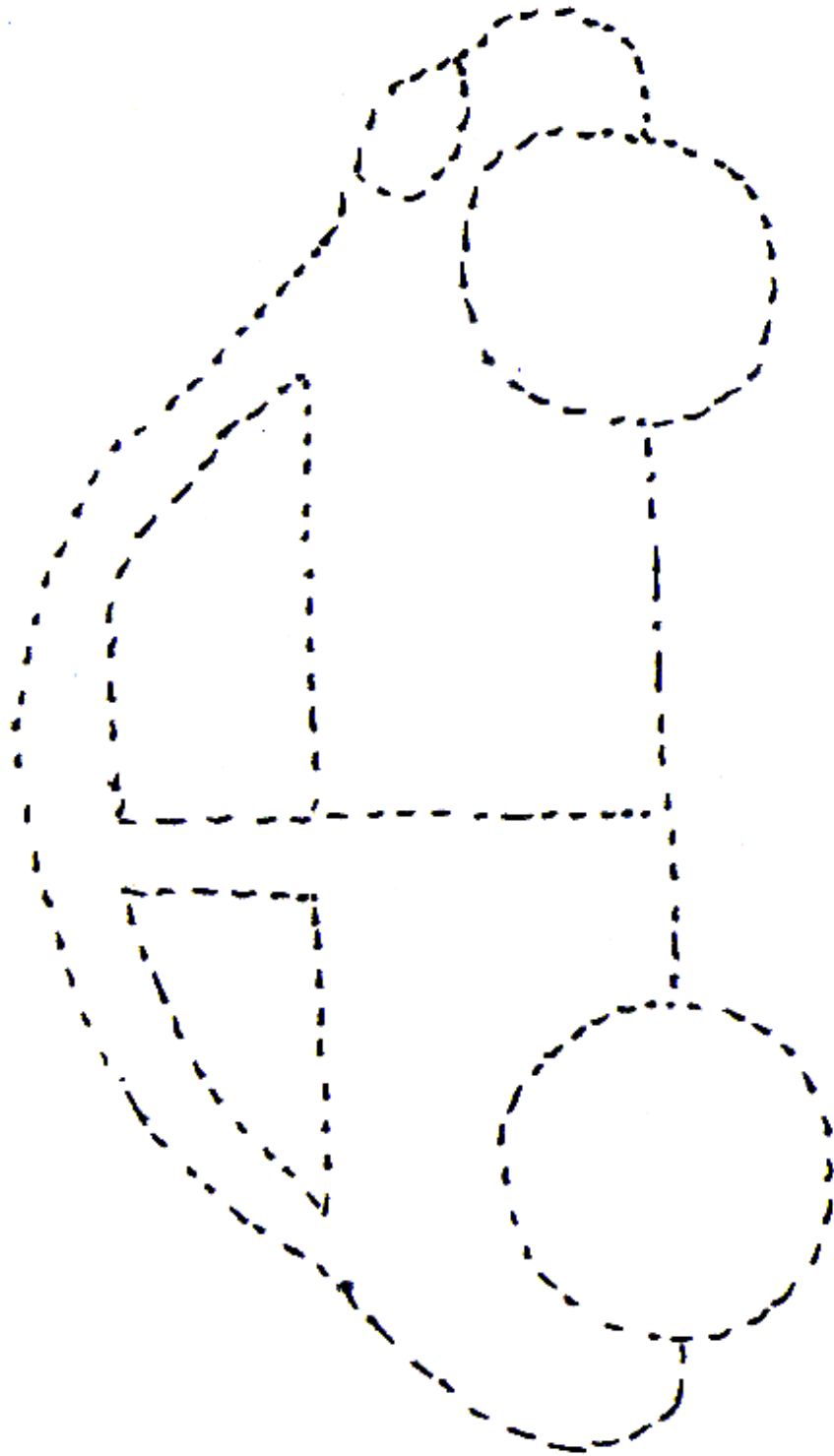

car

Name: _____

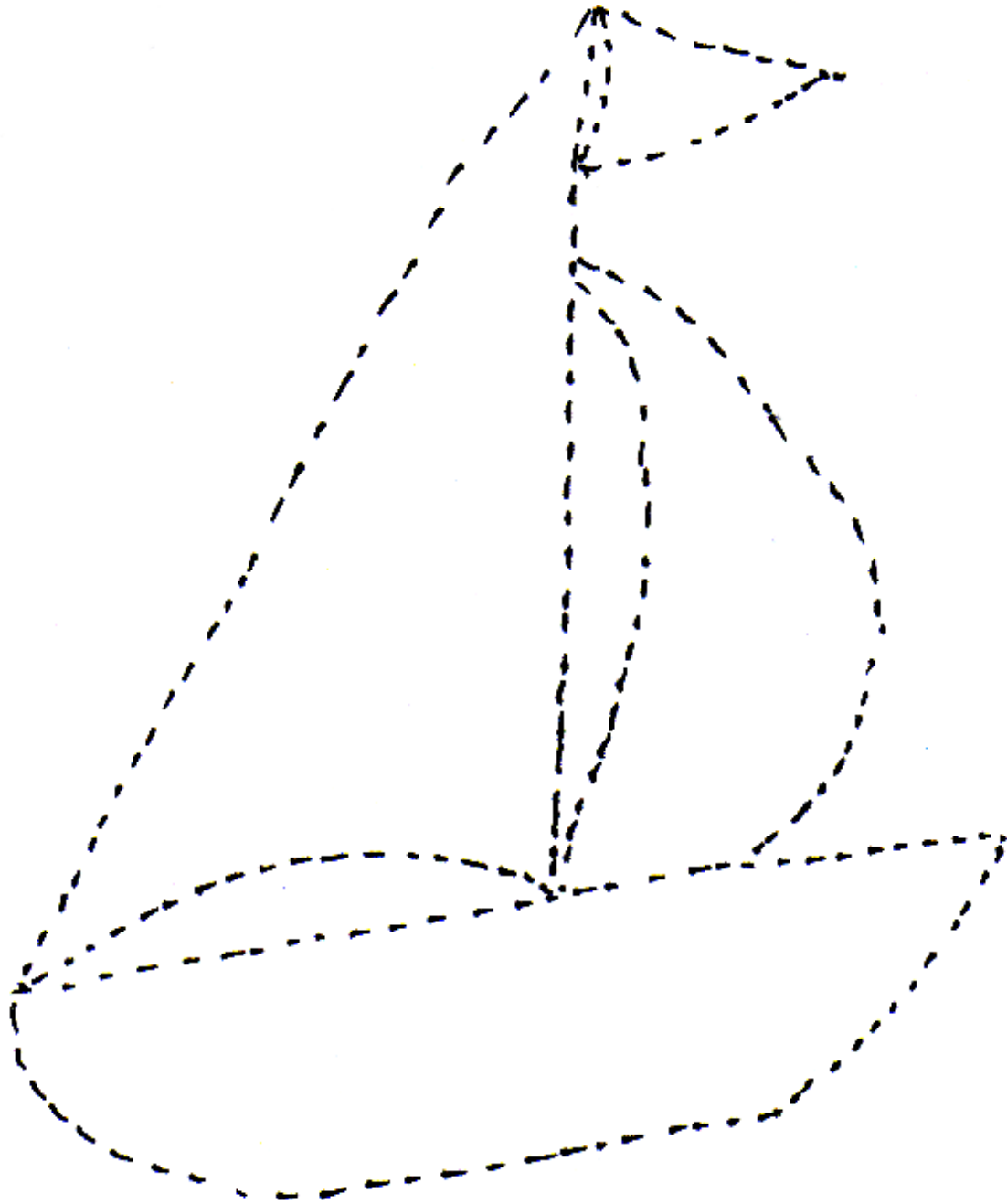

sail boat

Name: _____

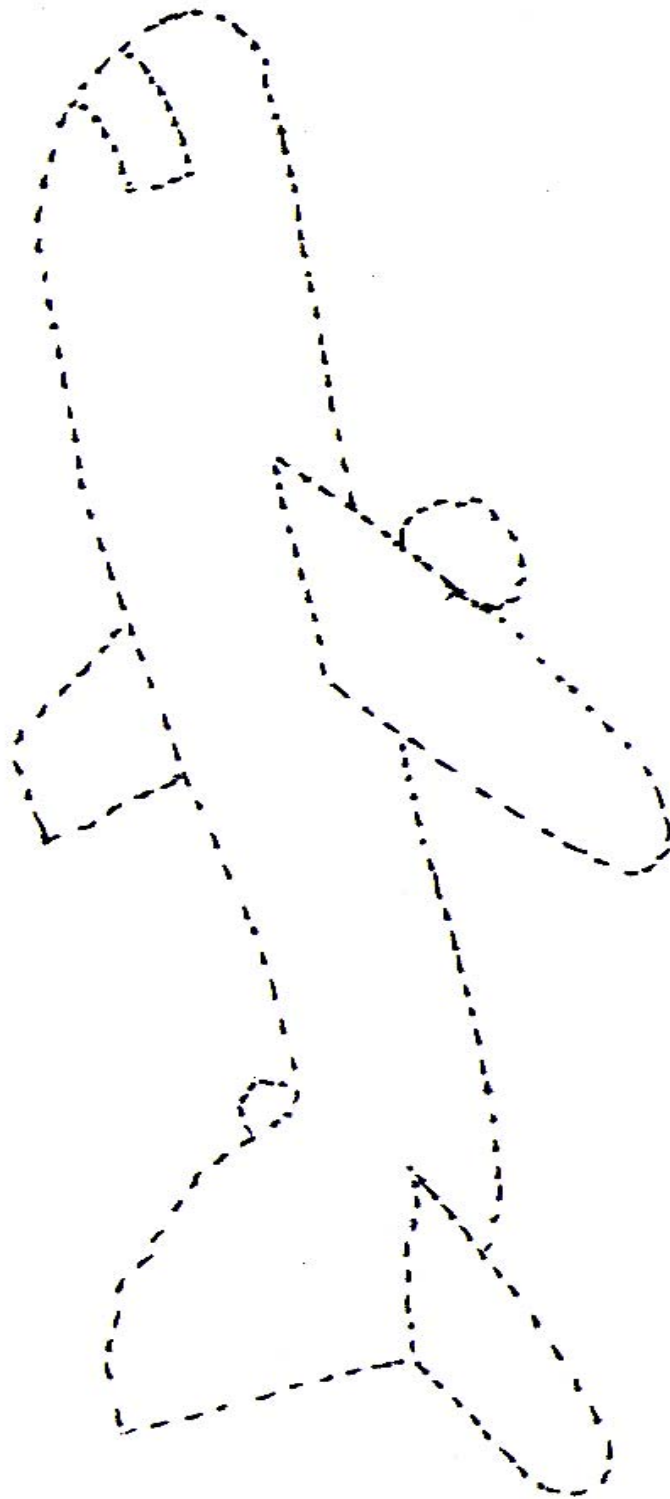

airplane

Name: _____

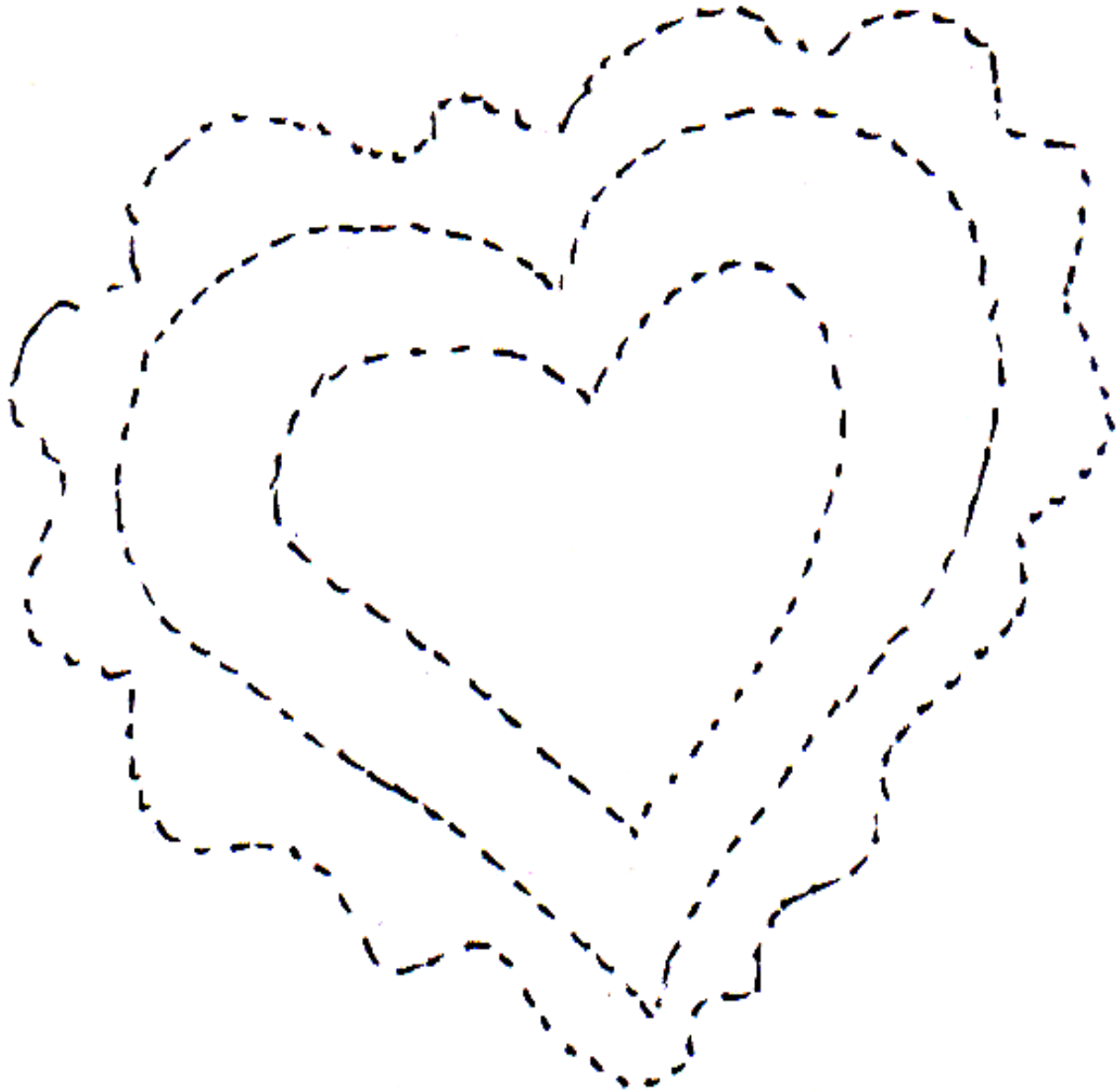

valentine